



GALLAGHER ESSENTIALS



UNIQUE IN THE MARKET
7-YEAR WARRANTY
ON ALL ENERGIZERS

www.gallagher.eu



For more information and prices go to our website

www.gallagher.eu



Welcome to Gallagher

Your specialist in electric fencing



Gallagher was founded in Hamilton, New Zealand in 1938, and has been the quality brand of electric fences for more than 80 years by now. With a large global distribution network, Gallagher is market leader in the electric fencing sector. We supply customers in a variety of markets, offering the most appropriate fencing solutions to either protect animals or keep other animals out.

Innovation has always been one of the main Gallagher spearheads. Our products are developed on the basis of an agricultural vision, and tested by end users. Once again this year, we have added a number of attractive and innovative products to our range. Take the new range of 9 V energizers for example. Whether you want to keep your animals under control, or to protect them against (wild) animals, Gallagher can always offer a suitable solution.

You receive a 7-year warranty on all our energizers!



At Gallagher, we believe in the quality of our products. Therefore you have a 3-year warranty on every Gallagher energizer and 4 years more when you register your energizer. See the website: <https://www.gallagher.eu/warranty>

For 7 years you are guaranteed that your energizer will work just as well as you may expect from a Gallagher energizer.

How does an electric fence work?	4
New products & Promotions	6
Energizers Calculator	10
i Series, general information	12
Energizers	14
i Series	14
Multipower i Series	15
Solar total solutions	16
230 V (Mains)	17
230 V/Battery (Multipower)	20
Boxes	23
Battery (12 V/9 V)	24
Solar	28
Batteries and accumulators	32
Earthing	34
Solar panels	36
Accessories	37
Fence and Earth connection lead	40
Testers	41
Pet kits	42
Posts	45
Permanent electric fence posts	45
Mobile electric fence posts	48
SmartFence	53
Reels	54
Conductors	56
Wires	56
Netting	58
Plastic wire, Tape, Cord	63
Insulators	67
Connectors	75
Gates	77
Tools	81
Step-by-step installation	83
Wire heights	84
Gallagher check/Maintenance	86
W&EID	88
Birth Alarm	90
Goodnature	92
Technical specifications	94
Index	106

How Electric Fencing Works

A short, safe and memorable shock to create a psychological as well as a physical barrier.

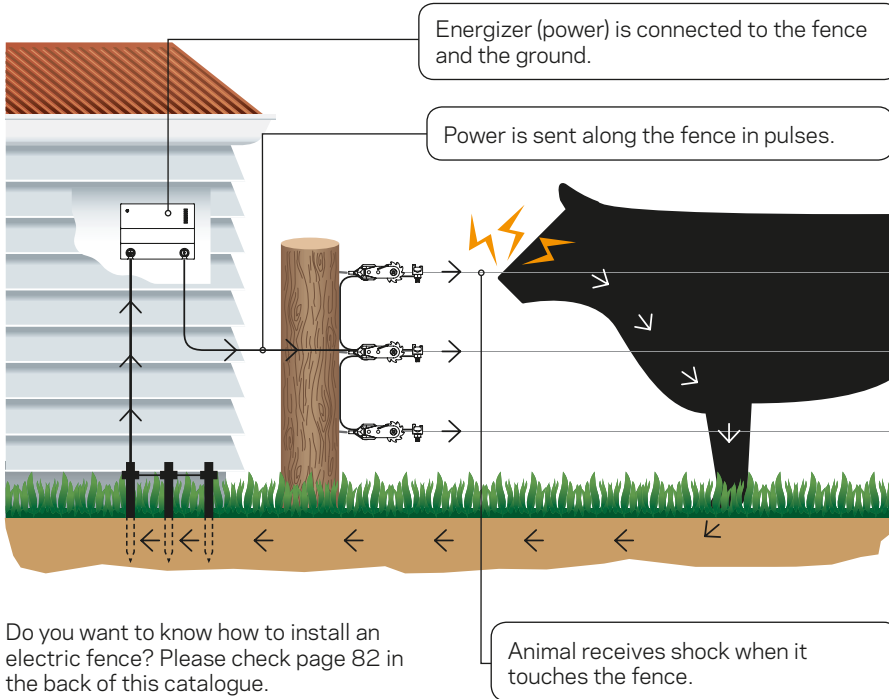

Do you want to know how to install an electric fence? Please check page 82 in the back of this catalogue.

SAFE

Animals remember and develop a respect for the fence

DURABLE

Stock pressure on your fence is reduced so it lasts longer

EASY TO INSTALL

Less than half the time to build vs a non-electric fence

ECONOMICAL

Costs less to build and maintain than a non-electric fence



7-year warranty on all Gallagher energizers!

The strength and quality of our products has been unrivalled for many years. That's why we give a 7-year warranty on all Gallagher energizers! Valid upon registration via the website. More information and terms: www.gallagher.eu/warranty



Getting Started...

Every electric fence system is made up of an energizer, a grounding system and a fence system.

Selection of these systems depends on property size, fencing usage and animal type.

1. **What animals do you want to keep in or out?**
2. **Total area to be fenced**
3. **What power source will you use for your energizer?**

Gallagher 230 Volt energizers are the best and most economical choice for areas where you have reliable power. Solar/Battery or Solar powered energizers are the most logical for remote areas.

4. **Do you need a permanent, offset or temporary/portable fence?**

- **Permanent:** Long life, permanent electric fences for highly effective animal control that lasts a lifetime.
- **Offset:** Protect and extend the life of an existing conventional non-electric fence by adding electric wire(s).
- **Temporary/Portable:** Easy to transport, assemble and take down allowing flexible fencing for short-term animal control or rotational grazing



Find out what your ideal fence is!

Try the Gallagher fence configurator.



<https://www.gallagher.eu/compose-electric-fence>

At Gallagher, we work non-stop to refine and extend our range. In 2022 therefore, we will once again be introducing a number of innovative products to both protect your animals and to keep out unwanted guests (predators). We are proud to once again present you with attractive products, based on our customer research.

Sheep netting

086252 - double spikes

086269 - single spikes

- Complete and easy to use portable netting for sheep and lambs.

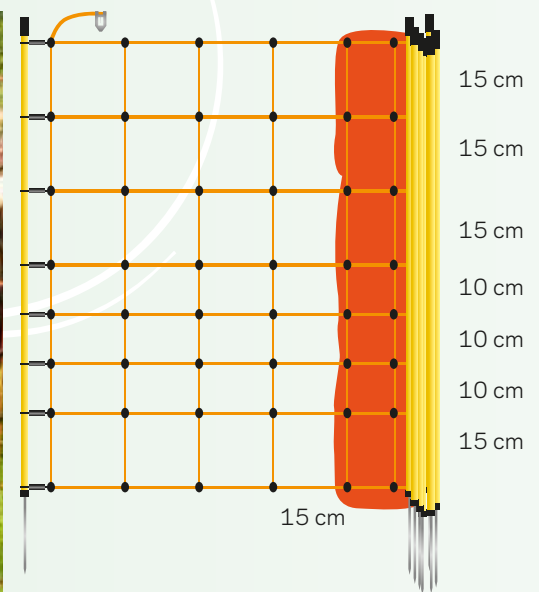
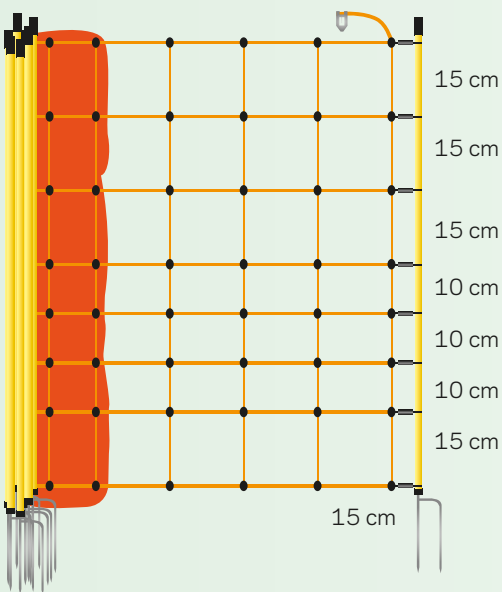

Vidoflex 9 TurboLine Plus 1000m

086290

- The blue colour is particularly for wild animals, because they see the colour blue very well. This keeps them out of your field with your domestic animals or crops.



Duopack Vidoflex 9 TurboLine Plus

086436 / 086443

- 52% stronger than traditional polywire. Will not twist or kink when winding onto reels. Ideal for long portable fences, the patented mixed metal conductive wires carry the pulse 40 times better than standard PowerLine wire.



Multi wire post

642833

- Multi-wire post with adjustable clip heights. This post is ideal for a wide variety of uses with adjustable clips making it easy to build a multi-wire ringtop post



S40LE

345321

- Works for three weeks without direct sunlight
- Super strong, fall-resistant, waterproof housing
- Quick and easy to install
- Built-in lightning protection

TurboStar Equiwire

912042 - White

912240 - Terra

- Even safer fencing for horses
- Developed and produced in New Zealand
- With a 10-year warranty

Superior conductivity

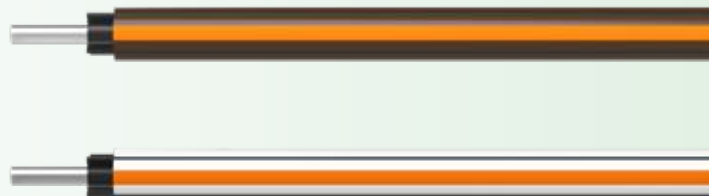

Pond and Garden kit 50cm S6 Solar

086504

- An ideal set for keeping pets out of your own garden or for keeping your neighbours' pets out. The S6 Solar is a compact, but powerful energizer.





BA30 + free battery

356303

- With the BA30 you can provide power for fencing of up to 4 km. The energizer is farm-proof and easy to move with the carry handle at the top. The BA30 has built-in lightning resistance and is supplied with a connection cable set.

MBS2800i/MBS1800i

306315 / 315317

- Powerful mains device
- Maximum control thanks to the external display.
- Keeps you informed of the fence performance.
- Find the exact location of the fault in the fence or switch the fence on or off using the remote control.



Reel + 500 m plastic wire

061184

- Reel with geared mechanism.
- Large handle with knuckle protection.
- Includes 500 m plastic wire.
- Includes multi-use gate handle



Screw-in Insulator Promopack (100)

071074

- With metal core
- High-quality black plastic

Gate handle with N-hook (10)

072408

- Gate handle with compression hook for easy use.

TurboLine Tape insulator

011087 - 20 pieces

021482 - 100 pieces

- Insulator with soft faces to lock the tape between two rubber sleeves (patented system) to prevent the wear off guaranteeing a long life for your tape.

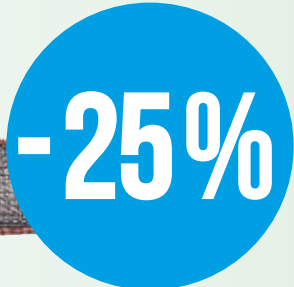
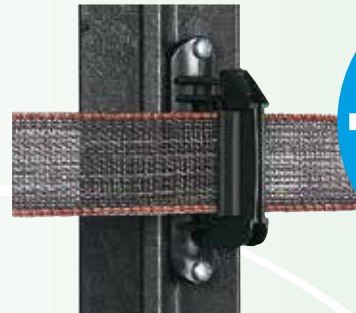

Extra discount on duo packs!
Up to 25% discount



Energizers Calculator

i Series

Super powerful and intelligent energizers that provide you with all the information you need about your fence

The i Series energizers have 'adaptive control': every normal energizer has a constant stored energy, whereas the i Series increases the output if the fence is under a greater load due to shorting. It means your fence is always 100% reliable, even when under a load. The i Series energizers can power fences of up to 100 km.

Furthermore, the i Series energizers are supplied with an external display that shows the status of your fence and that can be used to switch the energizer on and off. With the corresponding accessories, you can manage your energizer (remote control), your fence and the energizer with our app (Wi-Fi gateway) on your phone or you receive an SMS on your phone in case of loss of power (SMS module).



Mains energizers

With a mains connection nearby, these energizers provide the best and most reliable solution.

Always go for a mains energizer if you have a mains power point nearby, because these energizers are extremely reliable, powerful and consume little electricity. It is the most reliable way of powering your fence. No worries about batteries. Just put the plug in the socket and you always have a perfect power supply to your energizer.



Multi power energizers

The complete solution: mains, battery and solar energizers in one. Unique in the market!

A versatile energizer, suitable for a range of conditions. This is a battery energizer that can also be connected to a mains point with a plug. Or you can convert it into a solar energizer with a solar-panel kit. 3 in 1, versatile, multi power.

These MBS energizers have a Battery Management System: the energizer adapts automatically to the energy level of the battery. . If it is low, the time between the pulses is adjusted, extending the lifespan of the battery.



Solar

Smart energizers on solar power with a battery management system. Durable, environmentally friendly and extremely powerful.

With the Solar energizers you do not need a mains connection and you don't have to worry about an empty battery. The sun provides these energizers with sufficient power. Even on a cloudy day, the energizer will charge slightly with the available UV light. With the battery management system, the energizer automatically adjusts to the energy level of the battery. If it is low, the time between the pulses is adjusted, extending the lifespan of the battery.

The Gallagher solar energizers are easy to move, extremely durable, environmentally friendly, powerful and reliable. They are quick to set up and extremely suitable for areas that are difficult to reach.



Battery energizers

Easy to operate energizers for portable use. Lightweight and powered by a 9V or a 12V battery.

The ultimate solution when you need an energizer for fencing and you don't have a mains connection nearby. You connect a battery to the energizer and you have power on your fence in even the most remote areas. You can choose between 12V or 9V energizers. These energizers have a sturdy design and all the quality you may expect from Gallagher. The housing is resistant to all conditions and ensures these energizers have a long lifespan.



		Energizer	Part. No.														Page
i Series		M5000i	379326	9000	*19	15	100	60	26	▪	▪	▪	▪	▪			14
		MBS2800i	315331	7000	21	14	80	50	20	▪	▪	▪	▪	▪			15
		MBS1800i	315317	7000	14	10	65	40	17	▪	▪	▪	▪	▪			15
220 Volt		M1400	324319	7700	12	7,7	55	34	14	▪	▪	▪	▪	▪			17
		M950	324302	7700	9	6,1	42	31	11	▪	▪	▪	▪	▪			17
		M650	323329	9200	6,5	4,5	40	28	10	▪	▪	▪	▪	▪			18
		M550	323312	9200	5,5	3,9	35	25	9	▪	▪	▪	▪	▪			18
		M350	323305	8700	3,5	2,7	28	12	7	▪	▪	▪	▪	▪			18
		M160	384306	7700	1,6	0,6	9	3,5	2,5	▪	▪				▪	▪	19
		M120	033333	7000	1,2	0,6	8	3	2	▪	▪				▪	▪	19
		M50	038332	6200	0,5	0,3	4	2	1						▪	▪	19
Multi Power energizers		MBS800	390314	9200	7,5	4,9	40	29	10	▪	▪	▪	▪	▪			20
		MBS400	390307	9100	4	3	30	19	8	▪	▪	▪	▪	▪			21
		MBS200	389318	9000	2	1,5	20	13	5	▪	▪	▪	▪	▪	▪		21
		MB300	388328	9100	2,7	2	25	16	6	▪	▪	▪	▪	▪			22
		MB150	388311	8500	1,5	1,2	15	10	4	▪	▪	▪	▪	▪	▪		22
Battery 12V Energizers		B300	394008	10000	2,6	2	30	10	8	▪	▪	▪	▪	▪			24
		B200	393001	9000	1,5	1,1	20	7	5	▪	▪	▪	▪	▪			24
		B100	392004	10000	0,8	0,55	10	5	3	▪	▪	▪	▪	▪			24
		B60	388304	8500	0,6	0,4	8	2	1	▪	▪	▪	▪	▪	▪		22
Battery 9V Energizers		BA80	356358	9400	0,8	0,48	10	6	3	▪	▪	▪	▪	▪			26
		BA40	356327	9400	0,4	0,26	6	4	1,5	▪	▪	▪	▪	▪			26
		BA30	356303	9600	0,25	0,19	4	3	0,75	▪	▪	▪	▪	▪	▪		27
		BA20	356310	9600	0,17	0,12	2	1,5	0,5	▪	▪	▪	▪	▪	▪		27
		B10	003634	7900	0,1	0,07	1	0,5	0,5	▪	▪				▪	▪	27
Solar Energizers		S400	361307	9600	4	3,1	30	16	7	▪	▪	▪	▪	▪			28
		S200	360300	9600	2	1,6	20	10	5	▪	▪	▪	▪	▪			28
		S100	346304	9600	1	0,74	10	5	3	▪	▪	▪	▪	▪			29
		S40	345307	7900	0,4	0,26	5	3	1,5	▪	▪	▪	▪	▪	▪		29
		S40LE	345321	7500	0,36	0,23	5	3	1,5	▪	▪	▪	▪	▪	▪		30
		S20	341323	6900	0,2	0,14	3	1,5	1	▪	▪				▪	▪	30
		S16	341316	6900	0,16	0,13	1,5	0,8	0,5	▪	▪				▪	▪	30
		S12	349015	9200	0,12	0,08	1,5	0,7	0,4	▪	▪				▪	▪	31
	S6	349008	7500	0,08	0,06	0,5	0,2	0,1						▪	▪	31	

* Due to innovative techniques as strong as a 50 Joule energizer

The i Series system – the fence that talks to you.

Working together the i Series system provides fence information at a glance and if it detects any faults, it leads you directly to them, saving you hours of searching.

We are extremely proud of our i Series, as they are not only amazingly powerful devices (up to 100 km!), but they are also smart! The i Series gives you maximum control and helps you save time. So how does that work? By adding various accessories, you have direct insight into the status of your fence, however far away in the field. If there is an issue, you receive a signal on the display or on your smartphone. It tells you exactly where to find it. Saving you the search and therefore time. Many people have already discovered the great performance of this device. Will you be the next enthusiast?



By placing the remote control on the fencing, it becomes clear where the fault is located. The energizer can be switched off using the remote control.



The fencing monitor warns when the values for that zone drop below the set values.



Maximum control! Thanks to the separate, waterproof display you can read the status of the fencing and it can be operated up to a distance of 50 m from the energizer.

Unrivalled performance with a range of no less than 100 km. Developed in response to demand from the market.

Maximum control with your smartphone. Insight into the status of your fencing, fault alerts and switching the energizer on/off, wherever you are.



Checking 100 km of fencing....

... takes less time than reading this sentence!

Everyone wants to have power on their entire fence and the security that the animals stay safely behind it. So any owner will check the fencing regularly to see if there are any issues that could result in a lack of power.

Longer fences

That is relatively simple for a small fence, but what about fencing of 10 km or more? At that point, a daily check of the fencing soon takes up too much time, and is likely to be skipped. The result is a risk of power loss on the fencing and an unsafe situation for the animals. So Gallagher developed a smart solution so that you always know whether there is enough power on every part of the fence, without this taking up any time.

Visible on external display

By installing fencing monitors, in combination with any i Series energizer, it becomes clear how much power there is in that particular place. That status is shown on the display of the i Series energizers. The more fencing monitors you install, the clearer the

picture of your entire fencing.

You no longer need to go out to check your fencing. All you need to do is read the external display of the i Series energizers. Wherever you are!

Insight at all times

You can also see the status of your fencing on your smartphone. Thanks to the Gallagher smart app, you have real-time knowledge of the status of your fencing. If there is anything wrong, you receive an alert on your phone. You know which part of your fence has an issue and you can intervene quickly. Once on site, the remote control helps you to find the exact location of the problem.

ALL IN ALL, COMPLETE CONTROL OVER YOUR FENCING AND MASSIVE TIME SAVINGS!

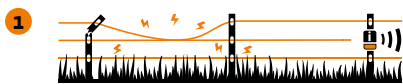

1 Fence Monitor(s) recognise any significant drop in fence zone or Energizer performance and raise alarms.



2 Alerts are sent to the Energizer Controller, your mobile phone (via optional Dashboard Fence App) and/or optional Alarm System.



3 The Controller and Remote indicate which zone is in fault. The Remote is used to find the fault within the zone.

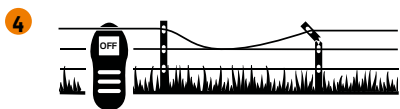

4 Once the fault is repaired, power is restored to the fence and tested using the Remote.

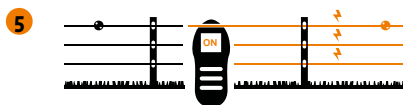

5 Power to the fence at the fault location is turned off using the Remote, allowing a safe and convenient repair.

DO YOU WANT TO
KNOW HOW THE
i SERIES SYSTEM
WORKS?



www.gallagher.eu/i-series

M5000i



The new powerhouse on the market

The mega-powerful M5000i is the latest addition to the familiar i Series, which represents ultimate power and absolute control.

The ultimate power is achieved thanks to the integrated Adaptive Control®. This provides continuous voltage on the fencing, any time anywhere, with the lowest possible electricity consumption. Energizers from the i Series burn away vegetation and ensure maximum power is retained at the end of the fencing.

SUPER POWER!



Powerful 15 Joule energizer
Up to 100 km

Easily monitor and control fence performance - Mount in a convenient location up to 50 m² from Energizer for easy access to fence control and performance information.



Reliable, adaptive i Series technology - The proven Gallagher i Series technology provides complete confidence in continued fence performance irrespective of changes in power supply, temperatures and fence conditions.

Compatible with i Series accessories - Fully compatible with i Series remotes, fence monitors, alarm system and the supplied display monitor (shown below).



M5000i

- LED bar with performance display
- Easy to use
- Built-in lightning protection
- Maintenance-free

379326	M5000i	 1
507002	i Series Remote Controller	 1
510002	i Series Fence Monitor	 1
567006	i Series WiFi Gateway	 1
567600	i Series SMS Controller	 1
579009	i Series Alarm System	 1
005215	Siren	 1
005208	Flashlight	 1

Item		Maximum output voltage (V)	Charging energy (J)	Maximum Impulse energy (J)	Number of earthing rods required	No vegetation (km) (recommended)	Light vegetation (km) (recommended)	Dense vegetation (km) (recommended)	Fence surface (ha) (recommended)
M5000i	379326	9000	19	15	8 × 2 m	100	60	26	160

MBS2800i and MBS1800i



Farm anywhere with market leading efficiency and the flexibility of mains, battery or solar. The Multi Powered i Series Fence Energizers allows for quick and easy monitoring of fence performance, informing you of any problems immediately so action can be taken quickly.



Easily monitor and control fence performance



Compatible with i Series accessories - Fully compatible with i Series remotes, fence monitors, alarm system and the supplied display monitor (shown below).

Reliable, adaptive i Series technology - The proven Gallagher i Series technology provides complete confidence in continued fence performance irrespective of changes in power supply, temperatures and fence conditions.



Designed for permanent installation where reliable mains power is available. Mains leadset supplied with product.











To ensure you never lose power on your fence, connect between the mains power supply and the Energizer and connect to your 12V battery as a back-up power source. Sold separately.



Designed for reliable power, all year round where mains power is unavailable or unreliable.

MBS2800i and MBS1800i

- o 12 V device can also be used on the power line
- o With a range up to 80km
- o Maximum control!
- o Unrivalled performance

PROMOTION	315331	MBS2800i		1
PROMOTION	315317	MBS1800i		1
	083053	Solar Powerstation MBS2800i		1
	083060	Solar Powerstation MBS1800i		1
	579009	i Series Alarm System		1
	005215	Siren		1
	005208	Flashlight		1
	582108	12V Battery Backup system		1
	401324	PowerSupply 230V/15V MBSi		1

Item		Maximum output voltage (V)	Charging energy (J)	Maximum Impulse energy (J)	Number of earthing rods required	No vegetation (km) (recommended)	Light vegetation (km) (recommended)	Dense vegetation (km) (recommended)	Fence surface (ha) (recommended)
MBS2800i	315331	7000	21	14	6 × 2 m	80	50	20	120
MBS1800i	315317	7000	14	10	5 × 2 m	65	40	17	75

Solarbox MBS2800i and MBS1800i



This solar station is plug and play. The energizer, the batteries, solar panel, earthing mix and earth pegs are all included. The only thing you need to do is ram the supplied earth pegs into the ground and connect the energizer. Simple, quick and time saving! This solar station can be expanded with all the accessories for the i Series energizers for even more control and convenience. With this set, you have everything you need for fencing conveniently together.



Solarbox MBS2800i and MBS1800i

- o MBS2800i / MBS1800i + external display
- o 4 gel batteries (MB2800i), 2 gel batteries (MB1800i)
- o 325 Watt solar module (mounted on the cabinet)
- o Bentonite earthing included
- o Included earth stakes

083053 Solar Powerstation MBS2800i 1

083060 Solar Powerstation MBS1800i 1

Item		Maximum output voltage (V)	Charging energy (J)	Maximum Impulse energy (J)	Number of earthing rods required	No vegetation (km) (recommended)	Light vegetation (km) (recommended)	Dense vegetation (km) (recommended)	Fence surface (ha) (recommended)
MBS2800i	315331	7000	21	14	6 x 2 m	80	50	20	120
MBS1800i	315317	7000	14	10	5 x 2 m	65	40	17	75

M1400 and M950



The M1400 and the M950 are strong mains energizers. These energizers have a built-in lightning conductor and a LED bar on the front that shows the voltage of the fencing. These energizers are among the Special Edition range offered by Gallagher. They stand out because of their quality and power, and are attractively priced. **IN OTHER WORDS: HIGH POWER, HIGH QUALITY, LOW PRICE.** The M1400 is suitable for fences of up to 55 km. The M950 is suitable for fences of up to 42 km.

More power in reserve
- Adaptive output control technology automatically adjusts to suite your fence conditions.

LED bar graph shows how Energizer is performing at a glance.



High performance livestock control - Highly efficient Energizer output delivers market leading performance, reliability and stock control.



Split bolt terminals for easy installation and good connection.



HIGH POWER ⚡ LOW PRICE

M1400 and M950

- o LED bar with performance display
- o Easy to use
- o Built-in lightning protection
- o Maintenance-free

324319	M1400		1
324302	M950		1

Item		Maximum output voltage (V)	Charging energy (J)	Maximum impulse energy (J)	Number of earthing rods required	No vegetation (km) (recommended)	Light vegetation (km) (recommended)	Dense vegetation (km) (recommended)	Fence surface (ha) (recommended)
M1400	324319	7700	12	7,7	4 x 2 m	55	34	14	56
M950	324302	7700	9	6,1	4 x 2 m	42	31	11	38

M650, M550 and M350



A mains energizer with a fantastic price/quality ratio. The M650, M550 and M350 are simple to install and easy to use. The M350 is suitable for fences of up to 28 km, the M550 up to 35 km and the M650 can power fences up to 40 km. These energizers are also among the Special Edition range offered by Gallagher.



Power on indicator. Green indicator light flashes when the Energizer is working.





HIGH POWER ⚡ LOW PRICE



M650, M550 and M350

- o Easy to use
- o Built-in lightning protection
- o Maintenance-free

323329	M650	 1
323312	M550	 1
323305	M350	 1

Item		Maximum output voltage (V)	Charging energy (J)	Maximum Impulse energy (J)	Number of earthing rods required	No vegetation (km) (recommended)	Light vegetation (km) (recommended)	Dense vegetation (km) (recommended)	Fence surface (ha) (recommended)
M650	323329	9200	6,50	4,5	3 × 2 m	40	28	10	26
M550	323312	9200	5,50	3,9	3 × 2 m	35	25	9	22
M350	323305	8700	3,50	2,7	3 × 2 m	28	12	7	14

M160, M120, M50 and M35



Mains energizers are extremely suitable for permanent fencing. The M160 and M120 are particularly suitable for larger gardens or small paddocks, up to a maximum of 9 km. The M50 and the M35 are ideal for keeping pets in small gardens (1 km) or for keeping out undesirable animals (such as stone martens and cranes) from your garden. The M160 is suitable for fencing up to 9 km, the M120 for fencing up to 8 km, the M50 up to a maximum of 4 km and the M35 is suitable up to a length of maximum 4 km.



Power on indicator. Green indicator light flashes when the Energizer is working.





Ground terminal

Fence terminal



M160, M120, M50 and M35

- Easy to use
- Built-in lightning protection
- Maintenance-free

384306	M160		1
033333	M120		1
038332	M50		1
383361	M35		1

Item		Maximum output voltage (V)	Charging energy (J)	Maximum Impulse energy (J)	Number of earthing rods required	No vegetation (km) (recommended)	Light vegetation (km) (recommended)	Dense vegetation (km) (recommended)	Fence surface (ha) (recommended)
M160	384306	7700	1,60	0,60	2 × 1 m	9,0	3,5	2,5	6
M120	033333	7000	1,20	0,60	2 × 1 m	8,0	3,0	2,0	4
M50	038332	6200	0,50	0,30	1 × 1 m	4,0	2,0	1,0	2
M35	383361	5400	0,35	0,23	1 × 0,5 m	2,0	1,0	0,5	1

MBS800 and Solarbox MBS800



Strong 12 V energizers that can also be connected to the mains or powered by solar panels. The extremely sturdy housing of these devices is resistant to frequent transport that is part and parcel of using a portable energizer. This MBS series has a Battery Management System, the device automatically adjusts to the energy level of the battery. If it is low, the pulse slows down too. All MBS energizers are supplied with a power feed adapter in order to be able to connect the energizers to the mains network (230 V). The connecting cable required to connect the device to the fence is also supplied standard.



MBS800 and Solarbox MBS800

- o Fast, flexible installation
- o Portable, water resistance case
- o Built in lightning protection
- o Including mains adapter
- o Including connection cable set

390314	MBS800	📦 1
083077	Solar Powerstation MBS800	📦 1
401324	PowerSupply 230V/15V MBSi	📦 1

Item		Maximum output voltage (V)	Charging energy (J)	Maximum Impulse energy (J)	Number of earthing rods required	No vegetation (km) (recommended)	Light vegetation (km) (recommended)	Dense vegetation (km) (recommended)	Fence surface (ha) (recommended)
MBS800	390314	9200	7,5	4,9	4 x 2 m	40	29	10	32
MBS800 Solarbox	083077	9200	7,5	4,9	4 x 2m	40	29	10	32

MBS400 and MBS200

With a solar-panel kit, an MBS energizer becomes a solar energizer. The solar-panel kit is supplied with a solar panel. Ideal for remote areas that are off-grid. Due to its intelligent design, the bracket can be attached to any wooden or a steel post.

The solar-panel kit contains a 20 W panel or a 40W panel and a mounting system. A sturdy bracket for mounting the solar panel and the energizer, connection materials and screws.



Any power source is possible - Designed for mains power, battery, battery with solar panel up to 16 hectares.

Also perfect to combine with the optional available MBS Solar kit!

20 Watt or 40 Watt panel

Unique bracket that is compatible with all MBS energizers, fits on any wooden or steel post.

MBS400 and MBS200

- o Fast, flexible installation
- o Portable, water resistance case
- o Built in lightning protection
- o Including mains adapter
- o Including connection cable set

390307	MBS400	☞ 1
495415	40W Solar kit + Bracket	☞ 1
389318	MBS200	☞ 1
495217	20W Solar kit + Bracket	☞ 1
582108	12V Battery Backup system	☞ 1
401324	PowerSupply 230V/15V MBSi	☞ 1

Item		Maximum output voltage (V)	Charging energy (J)	Maximum Impulse energy (J)	Number of earthing rods required	No vegetation (km) (recommended)	Light vegetation (km) (recommended)	Dense vegetation (km) (recommended)	Fence surface (ha) (recommended)
MBS400	390307	9100	4,0	3,0	4 × 1 m	30	19	8	16
MBS200	389318	9000	2,0	1,5	4 × 1 m	20	13	5	8

MB300, MB150 and B60



The MB300 and MB150 are multi-power energizers suitable for longer fences of up to 25 km and 15 km, respectively. These energizers work on 230 V and with a 12 V battery. The design means the energizer is easy to move and it can be mounted in various ways. The energizer is supplied with a set of cables. The MB300 and MB150 are energizers in the Special Edition Range; powerful devices for an attractive price.



MB300, MB150 and B60

- o Dual Power: 230 V plug in or battery power
- o Superior fence performance
- o Reliable animal control is assured with built in lightning control
- o Mains power supply sold separately
- o Battery not included

388328	MB300	1
388311	MB150	1
582108	12V Battery Backup system	1
401218	PowerSupply 230V/15V MB/MBS	1
388304	B60 - 12V/0,6J	1
086368	Battery 12V/80Ah Premium LA - 278x175x190	1
571102	Mount Solar post S10, S16, S20, MBS, MB and B60	1

Item		Maximum output voltage (V)	Charging energy (J)	Maximum Impulse energy (J)	Number of earthing rods required	No vegetation (km) (recommended)	Light vegetation (km) (recommended)	Dense vegetation (km) (recommended)	Fence surface (ha) (recommended)
MB300	388328	9100	2,70	2,00	4 × 1 m	25,0	16,0	6,0	12
MB150	388311	8500	1,50	1,20	3 × 1 m	15,0	10,0	4,0	6
B60	388304	8500	0,60	0,40	1 × 1 m	8,0	2,0	1,0	3

A robust carrying cabinet or burglar-resistant cabinet for all Gallagher MB and MBS devices. The carrying case is easy to carry because the case is provided of handles and bracket to fix the solar panel. Is made from quality sheet material. Gallagher recommends the vandal proof box if you want to secure the device, because the cabinet is live.

Vandal proof box



A galvanised box that protects battery and fence units. To deter vandals, the box is connected to the energizer. Outside box dimensions 412x270x565mm (LxWxH).



083046 Electrified Vandal Proof Box 1

Gallagher Solarbox



Portable box for energizer, battery and solar panel. Suitable for:
 Max. size of energizer: 380x110x300mm (lwxhx).
 Max. size of battery: 330x175x240mm (lwxhx).
 Gallagher solar panel 10W, 20W and 30Watt.



073511 Gallagher Solarbox 1

WHICH BATTERY IN WHICH BOX

	Part No.	Ah	Dimensions LxWxH mm	Weight (Kg)	Battery Box				
					Solarbox V1.0 Battery space 260x170x240	Solarbox V2.0 Battery space 330x180x240	**Vandalproofbox 2020< Battery space 360x260x230	***Vandalproofbox >2021 Battery space 360x240x230	Battery box Battery space 345x240x240
					073511	073511	019410	083046	025237
12Volt PremiumTurbo AGM	086382	105Ah	325x238x165	26,1		•	•	•	•
	086399	85Ah	237x197x171	20,3	•	•	•	•	•
	086405	65Ah	237x227x129	17,5	•	•	•	•	•
12Volt Premium LA	086351	105Ah	353x175x190	21,3			•	•	
	086368	85Ah	278x175x190	16,2		•	•	•	•
	086375	65Ah	242x175x190	13,9	•	•	•	•	•
12Volt VRSLA	033553	25Ah	166x175x125	8,0	•	• (2x vertical)	• (2x vertical)	• (2x vertical)	• (2x vertical)
9Volt Air Alkaline	063451	210Ah	190x125x160	4,6	•	•	•	•	•
	048588	175Ah	190x125x160	3,125	•	•	•	•	•
	008711	160Ah	190x125x160	3,075	•	•	•	•	•
	008704	120Ah	160x110x115	2,6	•	•	• (2x)	• (2x)	• (2x)
	007578	55Ah	160x110x115	1,6	•	•	• (2x)	• (2x)	• (2x)

*** The available height inside the box to divide between Energizer and battery is 455mm in total.
 *** The available height inside the box to divide between Energizer and battery is 500mm in total.

B300, B200 and B100



For strip grazing, temporary fencing or setting up electric fencing where there is unreliable or no mains power, a Battery Energizer System is a good choice

Quick glance indicator lights show battery and fence performance.



Easy battery installation with simple clip lock case.

Versatile animal control - vary energizer pulse modes to suit different animals.







Flexible fence management - choose from full or half power mode to extend battery life.

Carry handle for easy transportation.



B300, B200 and B100

- o 12 V energizer, battery fits in the case
- o For fences up to max. 30 km
- o Carry handle for easy transportation
- o Battery not included

394008	B300	 1
393001	B200	 1
068586	B200 including 6W solar assist	 1
392004	B100	 1
068609	Solar assist kit 6W for B100/B200/B300	 1
068709	Solar bracket B100/B200/B300	 1

Item		Maximum output voltage (V)	Charging energy (J)	Maximum Impulse energy (J)	Number of earthing rods required	No vegetation (km) (recommended)	Light vegetation (km) (recommended)	Dense vegetation (km) (recommended)	Fence surface (ha) (recommended)
B300	394008	10000	2,60	2,00	4 × 1 m	30,0	10,0	8,0	15
B200	393001	9000	1,50	1,10	3 × 1 m	20,0	7,0	5,0	10
B100	392004	10000	0,80	0,55	2 × 1 m	10,0	5,0	3,0	4

S220 and S230



Combination set of a B200 energizer, solar panel, bracket and a Premium Turbo AGM battery. The perfect, reliable combination for problem-free provision of power to your fence for many years. Maintenance free. Ideal for sunny regions and for fences up to 20 km. Contents of S230 and S220:



S230: B200 energiser, 30 W solar panel, bracket, and 3,7 L Premium Turbo AGM battery

S220: B200 energiser, 20 W solar panel, bracket, and 2,7 L Premium Turbo AGM battery

- o Total solution for a mobile fence
- o Battery unit on solar
- o Convenience for you!

060870	S230 (B200+30W+75Ah Premium Turbo AGM)	☞ 1
061556	S220 (B200+20W+60Ah Premium Turbo AGM)	☞ 1
068586	B200 including 6W solar assist	☞ 1

Item		Maximum output voltage (V)	Charging energy (J)	Maximum Impulse energy (J)	Number of earthing rods required	No vegetation (km) (recommended)	Light vegetation (km) (recommended)	Dense vegetation (km) (recommended)	Fence surface (ha) (recommended)
S230	060870	9000	1,50	1,10	3 × 1 m	20,0	7,0	5,0	10
S220	061556	9000	1,50	1,10	3 × 1 m	20,0	7,0	5,0	10

BA80 and BA40



**WITH WILDLIFE STAND
FOR ALL ANIMAL SPECIES
DEPLOYABLE**



Gallagher has revised its 9 V devices. They are all powerful battery devices that are simple to operate, and with a sturdy housing of the quality you've come to expect from Gallagher. The BA80 and the BA40 have a black housing with orange cover. These devices have an energy-saving setting. By using the energy-saving setting, you extend the life of the battery because the device gives slower pulses. The control lamp on the energizer shows the pulse of the battery. The BA80 and BA40 are suitable for larger (mobile) fences. The energizers are supplied with a set of connectors. Excluding battery.



Sustainable battery use.
The BA80 and BA40 has one extra setting to alternate between full pulse and reduced pulse. That means the battery lasts longer.

Market-leading 9 Volt Power
Connects to 9 Volt battery to power up to 10 km





Gallagher reliability.
Extensive testing and industry leading manufacturing processes



Designed for the outdoors
Water resistant case with built-in lightning protection

BA80 and BA40

- o Simple to connect, all lead sets included
- o With lightning protection
- o Robust housing, easy to operate
- o Additional setting to alternate pulse to extend battery life
- o Including connection kit
- o Excluding battery

356358	BA80		1
356327	BA40		1
7608	Earth Stake Stand BA		1
063451	Powerpack Alkaline battery 9V/210Ah - 190x125x160mm		1
065073	Duopack Alkaline battery 2x 9V/175Ah - 190x125x160mm		2

Item		Maximum output voltage (V)	Charging energy (J)	Maximum Impulse energy (J)	Number of earthing rods required	No vegetation (km) (recommended)	Light vegetation (km) (recommended)	Dense vegetation (km) (recommended)	Fence surface (ha) (recommended)
BA80	356358	9400	0,8	0,48	1 × 1 m	10,0	5,0	3,0	4
BA40	356327	9400	0,4	0,26	1 × 1 m	6,0	3,0	1,5	2

BA30, BA20 and B10



The BA30 and BA20 are strong and easy-to-operate 9 V energizers. Suitable for smaller fences. The energizers have a robust housing and are easy to operate. The BA30 and BA20 have a completely black housing and an indicator lamp to warn you when the battery is nearly empty. The energizers are supplied with a set of connector cables. The battery is not included.



BA30, BA20 and B10

- o Compact devices
- o Easy to connect
- o Can also be connected to 12V battery
- o BA20 and B10 excluding battery

PROMOTION

356303	BA30	🔌 1
356310	BA20	🔌 1
7608	Earth Stake Stand BA	🔌 1
065073	Duopack Alkaline battery 2x 9V/1.75Ah - 190x125x160mm	🔌 2
003634	B10	🔌 1

Item		Maximum output voltage (V)	Charging energy (J)	Maximum Impulse energy (J)	Number of earthing rods required	No vegetation (km) (recommended)	Light vegetation (km) (recommended)	Dense vegetation (ha) (recommended)	Fence surface (ha) (recommended)
BA30	356303	9600	0,25	0,19	1 × 0,5 m	4,0	3,0	0,75	1
BA20	356310	9600	0,17	0,12	1 × 0,5 m	2,0	1,5	0,5	0,8
B10	003634	7900	0,10	0,07	1 × 0,5 m	1,0	0,5	0,5	0,5

S400 and S200



The S400 and the S200 are the strongest devices in the Gallagher solar range. These energizers have a powerful solar panel and are fitted with the Battery Management System, ensuring that the energizer automatically adjusts to the battery's power level. If the energy in the battery decreases, the pulse adjusts to have current on the fencing for as long as possible. The S400 and S200 are supplied with batteries included and a stand (50 cm), that is also suitable for use as an extra earthing rod.



Battery Status Indicator - LED light shows battery health in an instant.

Water resistant case, with built in lightning protection



MOBILE AND POWERFUL!



S400 and S200

- o Multiple power options, the customer has full control, with multiple operation modes to suit wildlife animal exclusion and livestock animal inclusion.
- o Portable and quick to install, easily set up in any location and moved about as required allowing it to be used for strip grazing and better pasture management.

361307	S400 incl. batteries	1
360300	S200 incl. batteries	1
007509	Stand for S range Solar Energizers, length 90cm	1
033931	12V 7,2Ah Battery S100, S200, S400	1

Item		Maximum output voltage (V)	Charging energy (J)	Maximum Impulse energy (J)	Number of earthing rods required	No vegetation (km) (recommended)	Light vegetation (km) (recommended)	Dense vegetation (km) (recommended)	Fence surface (ha) (recommended)	Zonnepaneel watt
S400	361307	9600	4,0	3,1	4 × 1 m	30	16	7	16	40
S200	360300	9600	2,0	1,6	2 × 1 m	20	10	5	8	20

S100 and S40







The S100 and S40 are quick to install solar energisers and are easy to transport. No more hassle with empty batteries and you even have 3 weeks without sun still power. These energizers are equipped with a built-in lightning protection and are supplied including batteries.



S100 and S40

- o Multiple power options - two operating modes ensure optimum battery usage, even in periods of low sunlight:
- o Fully integrated, ready to use - includes fence/earth leadset, rechargeable 12v battery, solar panel and mains rechargeable power kit.

346304	S100 incl. battery		1
345307	S40 incl. battery		1
033931	12V 7,2Ah Battery S100, S200, S400		1
000459	6V 10Ah Battery S40/S40LE		1
007509	Stand for S range Solar Energizers, length 90cm		1

Item		Maximum output voltage (V)	Charging energy (J)	Maximum Impulse energy (J)	Number of earthing rods required	No vegetation (km) (recommended)	Light vegetation (km) (recommended)	Dense vegetation (km) (recommended)	Fence surface (ha) (recommended)	Zonnepaneel watt
S100	346304	9600	1,0	0,74	2 × 1 m	10	5	3	4	7
S40	345307	7900	0,40	0,26	1 × 1 m	5	3	1,5	2	4

S40LE, S20 and S16







These solar energizers are quick to install and easy to transport. No more hassle with empty batteries, because they are charged by the sun and by UV light on cloudy days. These energizers are fitted with a built-in lightning conductor and are supplied including batteries.



S40LE, S20 and S16

- o Operates in sunlight and daylight
- o Quick and easy to install
- o Ideal smaller (mobile) fences

345321	S40LE incl. battery	 1
341323	S20 incl. battery and mount	 1
341316	S16 incl. battery	 1
007509	Stand for S range Solar Energizers, length 90cm	 1
571102	Mount Solar post S10, S16, S20, MBS, MB and B60	 1

Item	Maximum output voltage (V)	Charging energy (J)	Maximum impulse energy (J)	Number of earthing rods required	No vegetation (km) (recommended)	Light vegetation (km) (recommended)	Dense vegetation (km) (recommended)	Fence surface (ha) (recommended)	Zonnepaneel watt
S40LE 345321	7500	0,36	0,23	1 × 1 m	5	5	3	2	4
S20 341323	6900	0,20	0,14	1 × 1 m	1,5	3	1,5	1,2	1,5
S16 341316	6900	0,16	0,13	1 × 1 m	0,8	1,5	1,5	0,8	1,5

S12 and S6



S12: A compact, portable and super reliable energizer that is designed on the basis of real, practical needs. An internal lithium battery, smart electronics and a robust construction come together for unrivalled performances. With built-in earthing and advanced solar technology, Gallagher has taken portable solar-powered energizers to a new level.

S6: The S6 has been developed for private users. For example, to keep cats out the garden or herons from the pond. The S6 is extremely suitable for the campsite or the garden as an energizer on a temporary fence, to keep pets near, or unwanted animals away.

SMALL BUT POWERFUL!



Easy to erect and equally easy to move, ideal solution for strip grazing

Fit on a ring top post and the conduction is sorted out straightaway suitable for fences up to 1.5 km

Includes cable set, rechargeable lithium battery and solar panel



S12 and S6

S12: < 1,5 km, **S6:** < 0,5 km

- o small and powerful
- o suitable for fencing of up to 1,5 km
- o to keep pets and other animals out
- o protect your pets and/or your garden

349015	S12 incl. Lithium battery	☞ 1
349008	S6 incl. Lithium battery	☞ 1
084197	Pet and Garden kit 80cm S6 Solar	☞ 1
086504	Pond and Garden kit 50cm S6 Solar	☞ 1

Item		Maximum output voltage (V)	Charging energy (J)	Maximum Impulse energy (J)	Number of earthing rods required	No vegetation (km) (recommended)	Light vegetation (km) (recommended)	Dense vegetation (km) (recommended)	Fence surface (ha) (recommended)	Zonnepaneel watt
S12	349015	9000	0,12	0,08	1x0,5m	1,5	0,7	0,4	0,75	2,2
S6	349008	7500	0,08	0,06	1x0,5m	0,5	0,2	0,1	0,1	2,2

To power a 9V or 12V energizer, you need a Gallagher battery. A Gallagher 12V energizer and an AGM 12V battery are the ultimate combination! The AGM battery is the most environmentally-friendly solution, because of its durability.



12V Premium Turbo AGM Battery

Unrivalled quality!! The Gallagher Premium turbo AGM batteries have an extremely low self-discharge, ensuring they last longer than traditional batteries. The battery is delivered filled and charged and can be used immediately. The battery can be charged by using a 12 Volt battery charger. Can also be used with solar panels.



086382	Battery 12V/100Ah Premium Turbo AGM - 353x175x190	☞ 1
086399	Battery 12V/75Ah Premium Turbo AGM - 278x175x190	☞ 1
086405	Battery 12V/60Ah Premium Turbo AGM - 242x175x190	☞ 1

12V SLA Battery

Maintenance free batteries. Suited for powering battery energizers. The 25Ah is a sealed lead/acid battery. Fits into the case of our 9Volt energizers when using a solar panel. Reliable and consistent power, long life span and maintenance free.



033553



033931

033553	Battery 12V/25Ah SLA - 166x175x125mm	☞ 1
033931	12V 7,2Ah Battery S100, S200, S400	☞ 1

12V Premium LA Battery

Are you looking for a no-maintenance battery? Go for the Gallagher 12V PREMIUM La batteries. This battery has a longer lifespan than the average 12V battery. Suitable for all 12V energizers and can also be combined with a solar panel.



086351	Battery 12V/105Ah Premium LA - 353x175x190	☞ 1
086368	Battery 12V/80Ah Premium LA - 278x175x190	☞ 1
086375	Battery 12V/65Ah Premium LA - 242x175x190	☞ 1

9V Powerpack Alkaline battery

Alkaline 9 Volt battery (mercury free!) for use with 9V battery powered energizers. Alkaline Batteries give you up to 30% better performance than Air Oxygen batteries. Suitable for all Gallagher 9Volt energizers

065073	Duopack Alkaline battery 2x 9V/175Ah - 190x125x160mm	📦 2
063451	Powerpack Alkaline battery 9V/210Ah - 190x125x160mm	📦 1
048588	Powerpack Alkaline battery 9V/175Ah - 190x125x160mm	📦 1
008711	Powerpack Alkaline battery 9V/160Ah - 190x125x160mm	📦 1
008704	Powerpack Alkaline battery 9V/120Ah - 160x110x115mm	📦 1
007578	Powerpack Alkaline battery 9V/55Ah - 160x110x115mm	📦 1



Why Gallagher Air Alkaline Batteries?

Compared to, for example, a zinc air or saline battery, the Gallagher Air Alkaline battery provides a considerably higher current output at a continuous voltage, with the result that the battery can provide an optimally reliable operating voltage throughout its life.

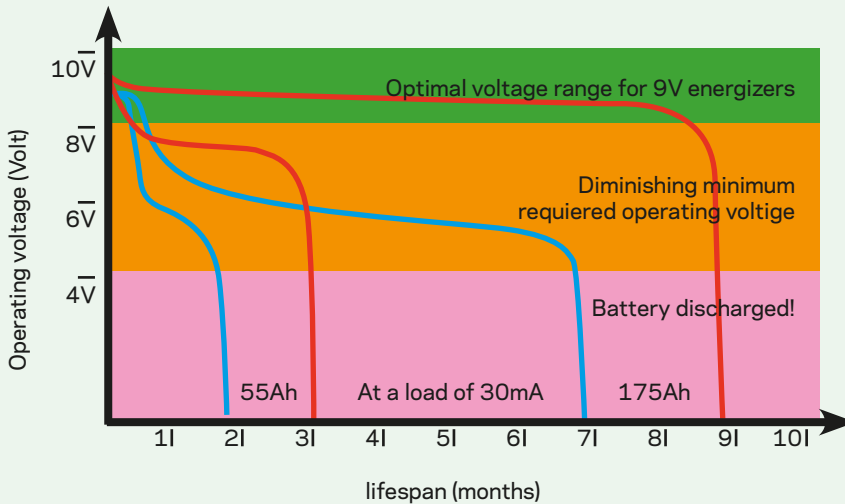

This makes the Gallagher Air Alkaline battery the best and most durable choice for use in your energizer.

— Gallagher air-Alkaline battery
— Standard zink-air battery

6V Round Alkaline battery

Environmentally friendly alkaline 6 Volt battery 90 Ah for use with battery powered energizers.



055661	Round battery Alkaline 6V/90Ah - 180x180x170mm	📦 1
--------	--	-----

6V 10Ah Battery S40/S40LE

6V 10Ah Battery, compatible with the S40, S40LE



000459	6V 10Ah Battery S40/S40LE	📦 1
075188	6V 4Ah Battery S10, S16, S20	📦 1

Battery for FoxlightS

Spare battery for the Fox light (061716)



002169	6V Battery for FoxlightS	📦 1
--------	--------------------------	-----

Premium 6/12V battery charger PRO 4.0

This Premium (Absaar) Pro 4.0 charger is a multi-purpose battery charger that can be used for both 6 and 12 Volt batteries. It is also ideal for battery maintenance and can be used to either top up a battery or recharge it from empty.



118645	Premium 6/12V battery charger PRO 4.0 Li 4A 6/12V	📦 1
--------	---	-----

Earthing ensures that the current can flow back to the energizer as soon as an animal touches the fence. No earthing means no current on the fencing, which is essential to good fencing!



Lead out cable



Earthing allows for back flow of power to the device when an animal hits the fence. Ground cable is a conductive supply cable: necessary for connecting the energizer to the fence. The ground cable also connects the device to the earth spike. In addition, ground cable is used to connect a grid underground to another part of the fence. E.g. a passage. Is the distance to be bridged more than 30 meters? Then use 2.5mm ground cable! Incl. meter marking.



162713	Lead out cable 2,5mm 400m 35 Ohm/km	🔌 1
021611	Lead out cable 2,5mm 100m 35 Ohm/km	🔌 1
062712	Lead out cable 2,5mm 50m 35 Ohm/km	🔌 1
065011	Lead out cable 2,5mm 25m 35 Ohm/km	🔌 1
021604	Lead out cable 1,6mm 50m 100 Ohm/km	🔌 1
066097	Lead out cable 1,6mm 25m 100 Ohm/km	🔌 1
065028	Lead out cable 1,6mm 10m 100 Ohm/km	🔌 1

Lead out cable XL Red



Robust ground cable with polyethylene sheathing (ensures that the ground cable is kept intact for longer). Can be used for earthing heavy equipment, for connecting several earth rods underground or for transporting electricity over long distances underground.



016276	Lead out cable 2,5mm XL High Conductive 200m 8,4 Ohm/km	🔌 1
627922	Lead out cable XL Red 2,5mm 50m	🔌 1

Earth stake

2

Allows current to flow back to the energizer as soon as an animal hits the fence. Always necessary for the proper functioning of the device. Always use galvanized earth stakes. Minimum length of earth stake: for 9V devices 0.5m, for 12V devices 1m and for mains devices (advice) 2m.



029037	Earthstake 2m with earth clamp	3
084487	Earthstake 1,7m with earth clamp	1
029020	Earthstake 1m with earth clamp	3
008735	Earthstake 1m without earth clamp	1
031023	Earth Stake 0,5m + 3m cable	1

Bentonite Super

Earthing can be achieved simply and quickly with this mix, even in extremely dry conditions. The mixture of salt and absorbent clay retains moisture and increases the conductivity of the surrounding soil. To be used in poor earthing conditions and in combination with more powerful energizers. Excl. earth stake. Including earth clamp.



008773	Bentonite Super Earthing Mix (6kg)	1
--------	------------------------------------	---

Earth socket

2

Earth socket for earth peg. Ideal to connect two pegs in bad earthing conditions.



044023	Earth Socket	1
--------	--------------	---

Earth Clamp

2

Earth clamp: guarantees a good connection between the earth stakes and lead-out cable from the energizer.



044030	Earth Clamp	1
--------	-------------	---

Lead-out connector

2

Excellent connections between different lead-out cables are essential to prevent power loss. This harsh environment connector for lead-out cables up to 2,5mm offers a secure, waterproof connection and is easy to install.



063796	Lead-out connector	2
--------	--------------------	---



Solar panels in combination with battery energizers extend the lifespan of your battery

- o Gallagher provides top-quality, tested solar panels with a 2-year warranty on all modules.
- o Solar power is environmentally friendly and an increasingly popular economical energy provider.
- o All solar panels have a controller that protects the battery against overcharging.
- o The range is completed with galvanised brackets, bolts and clamps.
- o All solar panels have polycrystalline cells for maximum energy yield.



Solar panel

12 VOLT

Polycrystalline high-performance solar module with optimised low-light and temperature features. With sealed high-performance load regulator. Shock-resistant and hardened solar glass with self-cleaning surface and sturdy aluminium frame. Complete with power cable. Very easy fitting. More than 20 year service life. Excluding mounting bracket.

041718	Solar panel 60W incl. 10A regulator	1
027897	Solar panel 50W incl. 10A regulator	1
041725	Solar panel 30W incl. 10A regulator	1
041732	Solar panel 20W incl. 2A regulator	1
041701	Solar panel 10W incl. 2A regulator	1



Solar panel bracket

2 VOLT

To mount the panel on the wall, post or on the anti-theft box.

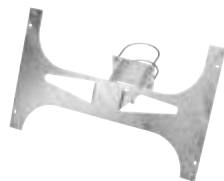

069781	Solar bracket 50/60W Solar panel	1
069774	Solar bracket 10/20/30W Solar panel	1

Solar panel regulator

12 VOLT

10A Regulator for 30W, 50W and 60Watt Solarpanel. Comes included with 3m cable, female cable terminals and Alligator clips.



068845	Regulator 10A for >30W Solar panels	1
068838	Regulator 2A for 10/20W Solar panel	1

Solar panel bracket

2 VOLT

Bracket for mounting a 10W, 20W or 30W GE Solarpanel to a B100, B200 or B300 Energizer.



068709	Solar bracket B100/B200/B300	1
--------	------------------------------	---

For more information and prices go to our website

www.gallagher.eu





i Series Remote Controller

2 YEAR WARRANTY

Remote controller to turn the fence on/off anywhere along the fence line. Integrated fault finder functions lead you to the problem in the fence. 'Inquire' function shows energizer display on the Remote Controller from anywhere on the fence. Works on all i Series energizers. The Remote has nine channels that can be "tuned in" to a specific energizer, enabling the Remote to control up to nine energizers.



507002 i Series Remote Controller 1

i Series Fence Monitor

2 YEAR WARRANTY

Allows you to create separate zones in your fence and will allow you to receive specific information about that zone. The Fence Monitor communicates through the fence line with the energizer.



510002 i Series Fence Monitor 1

i Series WiFi Gateway

2 YEAR WARRANTY

Fence performance in your pocket! Connect the i Series WiFi Gateway to your existing Gallagher i Series energizer, install the AgDevices app on your phone and get real time fence information. The WiFi Module will connect to the port on the back of the i Series energizer. The controller is then connected directly to the WiFi Gateway.



567006 i Series WiFi Gateway 1

DOWNLOAD THE NEW FREE APP AND EXPERIENCE THE CONVENIENCE!

✓ TIME SAVINGS

In-situ checks no longer required.

✓ REAL TIME OVERVIEW

Checks in the field are snapshots. The app monitors everything continuously.

✓ SWITCH THE ENERGIZER ON/OFF REMOTELY

Work safely without having to cover long distances.

✓ ADD UNLIMITED ACCOUNTS

More people receive alerts, and that means more control.



i Series Alarm System



Monitor a section of fence and drive external strobe lights, sirens or alarm panels.

The Alarm System provides an alarm on the Energizer Controller, Remote or your phone (via the separately available i Series SMS Controller), should an electric gate be opened or wire cut. Connects to the energizer by wired connection.



579009 i Series Alarm System 1

005215 Siren 1

005208 Flashlight 1

SMS remote control (GSM)



With the (GSM) SMS remote controller you can switch all mains energizers on and off by calling or texting with your mobile phone. So if you detect a fence failure, you can instantly repair your fence without getting a shock. Even in case of sudden power failure, the system will send a text message.



557063 SMS remote control with Power failure alarm (GSM) 1

Lightning diverter



The only adjustable lightning protector on the market and therefore ideal for any energizer. Protects the energizer from lightning damage by routing lightning from the fence to ground (earth). The lightning protector is mounted between the fence and the device and must be connected directly to the earth (or own earth stake). Can protect against multiple impacts.



064802 Lightning diverter 1

Aluminum warning sign



Warning signs must be attached to any electric fence every 50 metres wherever the fence borders a public right of way.



082216 Aluminium EU Warning sign 1

12V Battery Backup system



The Gallagher battery back-up provides an automatic battery supply when there is no mains supply to the energizer. The back-up is easy to install and compatible with all MB i Series and MB/MBS energizers.



582108 12V Battery Backup system 1

Cut out switch



By using a switch, you can divide your fence into several sections and switch them on and off independently of each other. This will also help you trace any faults that occur.



060705 Cut out switch 1

Flood gate controller



Acts as a safeguard when a fence is over a ditch. It stops the current flowing in the bottom wire of the fence when water reaches the bottom wire. The rest of the fence will keep its voltage.



1506 Flood Gate Controller (5600 Ohm) 1

EU Warning sign



Warning signs must be attached to any electric fence every 50 metres wherever the fence borders a public right of way.



075881 EU Warning sign (universal) 1

			MBS1800i 315317	MBS2800i 315331	M5000i 399326
303376		i Series Extern display	●	●	●
507002		i Series Remote Controller	○	○	○
510002		i Series Fence Monitor	○	○	○
579009		i Series Alarm System	○	○	○
567006		i Series WiFi Gateway	○	○	○
582108		12V Battery Backup system	○	○	-
557063		SMS remote control with Power failure alarm (GSM)	○	○	○
401324		PowerSupply 230V/15V MBSi	●	●	-
005215		Siren	○*	○*	○*
005208		Flashlight	○*	○*	○*

● Included

○ Optional

- Not available

* Only combined with 579009



Fence lead sets			Suitable for Unit
004938		Fence and Earth connection lead for 9V/12V Energizers 1	B20, B35, B60, BA20, BA30, BA40, BA80, S10, S16, S17, S20, S22, S50, S40, S100, S200, S400, MB150, MB300, MBS200, MBS400, MBS800
201276		Fence and Earth connection lead for 9V/12V Energizers 1	B40, B50, B100, B200, B300, B80, B180, B280, S220, S230
006345		Multi reel connector set 1	For interconnecting 3 polywires / tape in a Multi reel setup

Battery lead sets			Suitable for Unit
005499		12V Battery connection lead for 9V Energizers 1	B20, B35, BA20, BA30, BA40, BA80
201283		12V Battery connection lead for 9V/12V Energizers 1	B40, B50, BX50, B100, B200, B300, S220, S230."
582207		12V Battery Lead set MB/MBS Series 1	MB150, MB300, MBS200, MBS400, MBS800, MB1000, MBS1800i, MBS2800i
001015		12V Battery connection lead for B60 (1) 1	B60 Unit before 2020

Spare Crocodile clips			Suitable for Unit
400211		Crocodile clip green 5	All Fence lead sets
400204		Crocodile clip red 5	All Fence and Battery lead sets

230V/15V			Suitable for Unit
401324		PowerSupply 230V/15V MBSi 1	*B80, *B180, *B280, MB150, MB300, MB1000, MBS200, MBS400, MBS800, MBS1800i, MBS2800i
401218		PowerSupply 230V/15V MB/MBS 1	*B80, *B180, *B280, MB150, MB300, MBS200, MBS400, MBS800

* Only latest B models with external battery connector

For more information and prices go to our website

www.gallagher.eu



Would you like to prevent your animals from escaping as result of a lack of current? Would you like to know what caused the short-circuit in your fencing? Do you want to protect your energizer against a lightning strike? You can with our range of protectors and testers!

i Series Remote Controller

2 YEARS

Remote controller to turn the fence on/off anywhere along the fence line. Integrated fault finder functions lead you to the problem in the fence. 'Inquire' function shows energizer display on the Remote Controller from anywhere on the fence. Works on all i Series energizers. The Remote has nine channels that can be "tuned in" to a specific energizer, enabling the Remote to control up to nine energizers.



507002 i Series Remote Controller 1

Fault Finder

2 YEARS

Pinpoints faults quickly and easily whatever type of wire or energizer is used. By simultaneously measuring the current flow and voltage, the Fault Finder will follow the current flow to any one of a series of faults.



509051 Fault Finder 1

202068 Battery Fault Finder 1

Fence Volt Meter

2 YEARS

Supplies exact information on the condition of your fence. Makes targeted trouble shooting very easy. Auto ON/OFF. Helpful tool for checking earthing system. Powered by one 9V battery (a life of 6-12 months). Displays fence voltage from 100V up to 12kV.



015033 Fence Voltmeter 1

Neontester

2 YEARS

A convenient tool for checking whether there is sufficient voltage on the electric fence. Not suitable for checking earth systems.

Range: Led 1, 1,0kV > 1,8kV, Led 2, 1,9kV > 2,5kV, Led 3, 2,6kV > 3,8kV, Led 4, 3,9kV > 4,8kV, Led 5, 4,9kV >



015019 Neontester 1

Live fence indicator

2 YEARS

Checks and warns with light signals whether there is still sufficient voltage on the fence. A bright flash = fence ok. Slow flashing light = reduced voltage. No flash = no voltage. Visible up to 1 km from the fence.



511009 Live Fence Indicator 1

Electric fence Keyring Beeper

2 YEARS

A very handy and simple tester which can be attached to a key ring. Hold it close to an electric fence and it will give a loud beep if the fence is active.



079667 Electric fence Keyring Beeper 1

With the Gallagher fencing kits you have everything you need for electric fencing. The kits consist of a set of wire, an energizer and connectors. You can create a solution for any situation, to keep animals in or out of your garden.

The pet kits are suitable for keeping dogs or cats in or out of your garden, to protect your pond against herons, or your house from unwanted guests. There are also complete kits for rabbits, chickens or other poultry. Go for convenience, but with the quality you may expect from Gallagher.



Pet and Garden kit



This set works with an energizer (S6) on solar power. A mains connection is not required, and the energizer can be put in any required place in the garden or on the campsite. This set consists of: S6, 100 m plastic wire, 4 wire connectors, 10 fencing posts of 80 cm, 40 wire clips, 8 screw insulators, 1 connection set, 1 earth peg and 1 warning sign.



084197 Pet and Garden kit 80cm S6 Solar 1

Pet and Garden kit



An ideal set for keeping pets out of your own garden or for keeping your neighbours' pets out. The M35 is a compact, but powerful mains energizer.



083091 Pet and Garden kit 80cm M35 230V 1

Pond and Garden kit 50cm S6 Solar



An ideal set for keeping pets out of your own garden or for keeping your neighbours' pets out. The S6 Solar is a compact, but powerful energizer.



086504 Pond and Garden kit 50cm S6 Solar 1

Pond and Garden kit



An ideal set for keeping pets out of your own garden or for keeping your neighbours' pets out. The M35 is a compact, but powerful mains energizer.



083107 Pond and Garden kit 50cm M35 230V 1

Cat kit for fence



This fencing kit is easy to install and extremely effective in use. It means the neighbours' cat can no longer enter your garden. The M35 is a mains energizer.



083121 Cat kit for fence M35 230V 1

Starter kit M35 230V



The ideal basic set for effective fencing for pet and other applications around your house and in your garden. The starter kit contains the most important elements for electric fencing for keeping your dogs and cats out your garden and flower beds.



083114 Starter kit M35 230V 1

Poultry kit B60



A complete kit for setting up 50 metres of electric netting 44" (112cm) to keep your poultry in and protect them against predators. Installing is made easy due to a step by step manual. The kit includes: B60 (12V), Poultry netting, double spike, 112cm (50m), Earth peg, Warning sign.



072309 Poultry kit B60 12V 1

Marten kit



Basic set for keeping martens off your land. With good electric fencing you reduce the chance of martens causing damage to your house or other property. This set contains insulators that can be installed on the down pipe.



083138 Marten kit M50 230V 1

083923 Gutter clamp insulator Marten Kit 5

083916 Rainpipe clamp Insulator Marten Kit 1

SnailFence kit S6 Solar (20m)



Snail tape kit Gallagher's "Out of the Box" solution: With this kit, snails are in your vegetable garden a thing of the past. The tape is quick and easy to install to install. This kit contains: 1x Gallagher S6 Solar Energizer, 1x20 meter Snail fence tape, 1x Mounting box, 200x Screw M3x12, 10m ground cable, 1x Screw and plug set and manual.



086511 SnailFence kit S6 Solar (20m) 1

077434 SnailFence tape extension kit 50m 1

077427 SnailFence tape extension kit 20m 1

500041000 Snailfence Junctionbox 1

FoxlightS



The way to protect your venerable animals against attacks from foxes and other night predators. 9 LED bulbs blink randomly so that the illusion is created for predators that someone is patrolling the area. 6 Volt battery is not included.



061716 FoxlightS 1

002169 6V Battery for FoxlightS 1



Gallagher has two types of posts - posts for temporary fencing and posts for permanent fencing. The 'permanent' posts - Insultimber, Linepost, and Ecopost - differ from each other in terms of quality, sustainability and price. We also have 'portable' posts in various types, colours and heights, including plastic posts, fibre-glass posts and metal posts. Gallagher has a suitable post for every type of fencing.



Insultimber (FSC®)



Wooden post for a permanent fence. Self-insulating, so no need to use insulators. Wire can be attached with mounting wires. 100% natural product! Sheep fence with Insultimber (FSC®) posts? Save material and costs by installing a fixed pole (length 1.50m) for long straight sections and a batting of 1m (pole without point) on every intermediate 10m. Integrates perfectly into the landscape. This is the most effective natural barrier. Maintenance free. Long lifespan. Product warranty: 10 years. Lifespan: up to 30 years!



The mark of responsible forestry

FSC products available on request



017904	Insultimber (FSC®) Strainer post 250x10x10cm	☞ 1
017898	Insultimber (FSC®) Strainer post 200x8x8cm	☞ 1
017997	Insultimber (FSC®) Strut 200x4x8cm	☞ 1
007847	Insultimber (FSC®) Post 210x5x5cm	☞ 1
007724	Insultimber (FSC®) Post 180x3,8x3,8cm	☞ 1
007601	Insultimber (FSC®) Post 150x3,8x3,8cm	☞ 1
007854	Insultimber (FSC®) Dropper 156x3,8x2,6cm	☞ 1
007733	Insultimber (FSC®) Dropper 126x3,8x2,6cm	☞ 1
019403	Insultimber (FSC®) Dropper 110x3,8x2,6cm	☞ 1
007618	Insultimber (FSC®) Dropper 95x3,8x2,6cm	☞ 1

035311	Rammer Insultimber post	☞ 1
017614	Sledge hammer	☞ 1
704668	Post holer 100mm	☞ 1
704644	Post holer 75mm	☞ 1
024704	Clips long for Insultimber/Ecopost	☞ 1000
011063	Clips long for Insultimber/Ecopost	☞ 50
024698	Clips short for Insultimber/Ecopost	☞ 1000
011056	Clips short for Insultimber/Ecopost	☞ 25

AWARD WINNER - THE INSULATED LINE POST

Super-efficient fencing solution

The insulated line post with clips is the new solution for permanent fencing. Ideal for leased pasture or difficult to reach pasture. This perfectly insulated post can be positioned and removed by hand without any difficulties. It is just as firmly in the ground as a permanent wooden post, because of the solid foot plate. Due to the fibreglass core and the hdpe coating, it is extremely flexible and gives a little when an animal or something else contacts the fencing. The post really is a complete solution with the corresponding clips that are suitable for all types of Gallagher conductors.



LINE POST DROPPER 0,95M

The perfect fence with fewer posts
Save 30% on your fence!

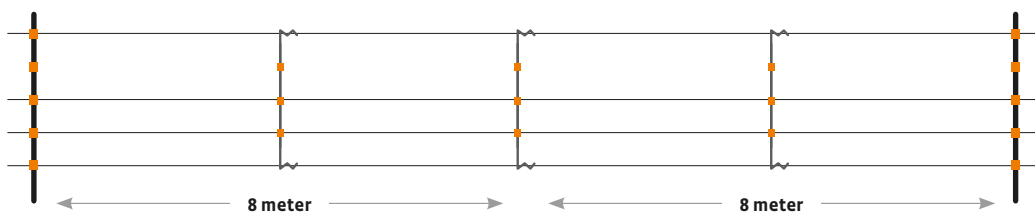

Gallagher Insulated Line Post



Gallagher Insulated Line Post (2,05 m), unique and durable design and extremely suitable for permanent fencing. Full self-insulating and extremely quick and easy to set up. The conductor can be attached to various pre-shaped positions with LinePost Clips that are available separately. The maximum wire height is 1.50 m. The unique and durable benefits of this post are achieved by combining a fibreglass core with a UV-protected polyethylene exterior.

Product warranty: 10 years. Lifespan: 25 years or more!



742335	Gallagher Insulated Line Post 2,05m	☞ 10
742212	Gallagher Insulated Line Post 1,90m	☞ 4
742014	Gallagher Insulated Line Post 1,40m	☞ 4
717135	Gallagher Insulated Line Post Dropper 0,95m 5 wire	☞ 10
082285	Wire clip insulator for Gallagher Line Post	☞ 100
744346	Wire clip insulator for Gallagher Line Post	☞ 20
082278	TurboLine Tape clip insulator for Gallagher Line Post	☞ 100
747033	TurboLine Tape clip insulator for Gallagher Line Post	☞ 12

525013	Line Post Rammer	☞ 1
530031	Line Post Rammer sleeve	☞ 1
540016	Line Post Pilot	☞ 1
527017	Line Post Lifter Adapter	☞ 1
106151	Screw-in Tie Down	☞ 5
006161	Tie Down Handle for Screw-in Tie Down	☞ 1



Eco post



Plastic post for a permanent fence. Self-insulating, so no need to use insulators. Wire can be attached with mounting wires. Stands firmly in the ground due to the special cross profile (Ø 70mm). With pre-assembled holes at preferred height. Maintenance free. Long lifespan. Product warranty: 10 years. Lifespan: up to 30 years!



009534	Eco post 185x7cm	☞ 4
009527	Eco post 150x7cm	☞ 4
017652	Rammer Eco post	☞ 1
024704	Clips long for Insultimber/Ecopost	☞ 1000
011063	Clips long for Insultimber/Ecopost	☞ 50
024698	Clips short for Insultimber/Ecopost	☞ 1000
011056	Clips short for Insultimber/Ecopost	☞ 25

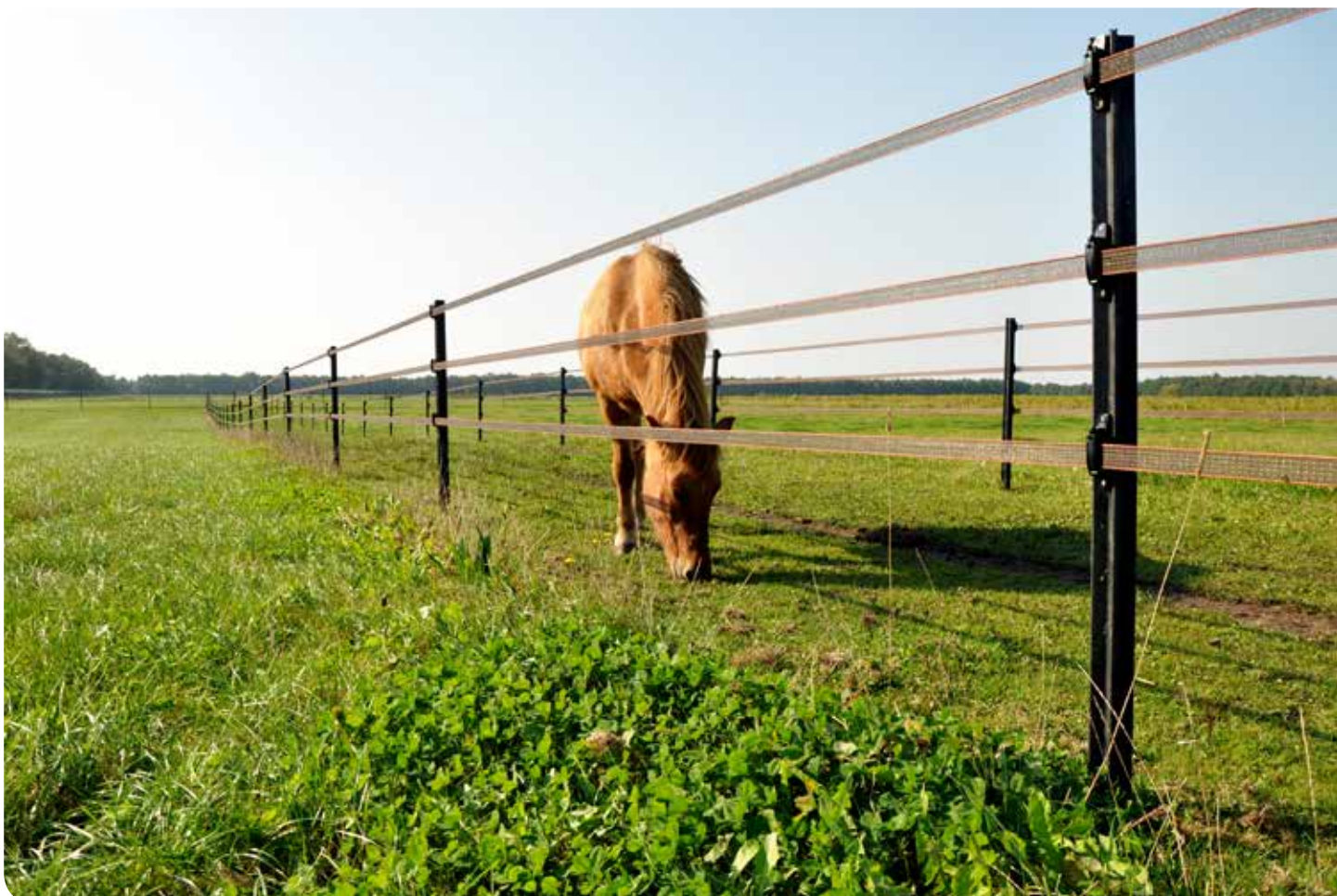

Light and easy to move

Gallagher also has portable posts in various types and sizes, including plastic posts, fibreglass posts and metal posts. They are all light-weight and easy to move. For example, we have plastic posts with wire holders so you do not need any loose insulators. The tread-in post has been developed specifically for portable horse fencing. You can take 50 of these smoothly finished posts in one hand when you fence off your pasture. You already know the spring steel post with pigtail insulator. Super tough

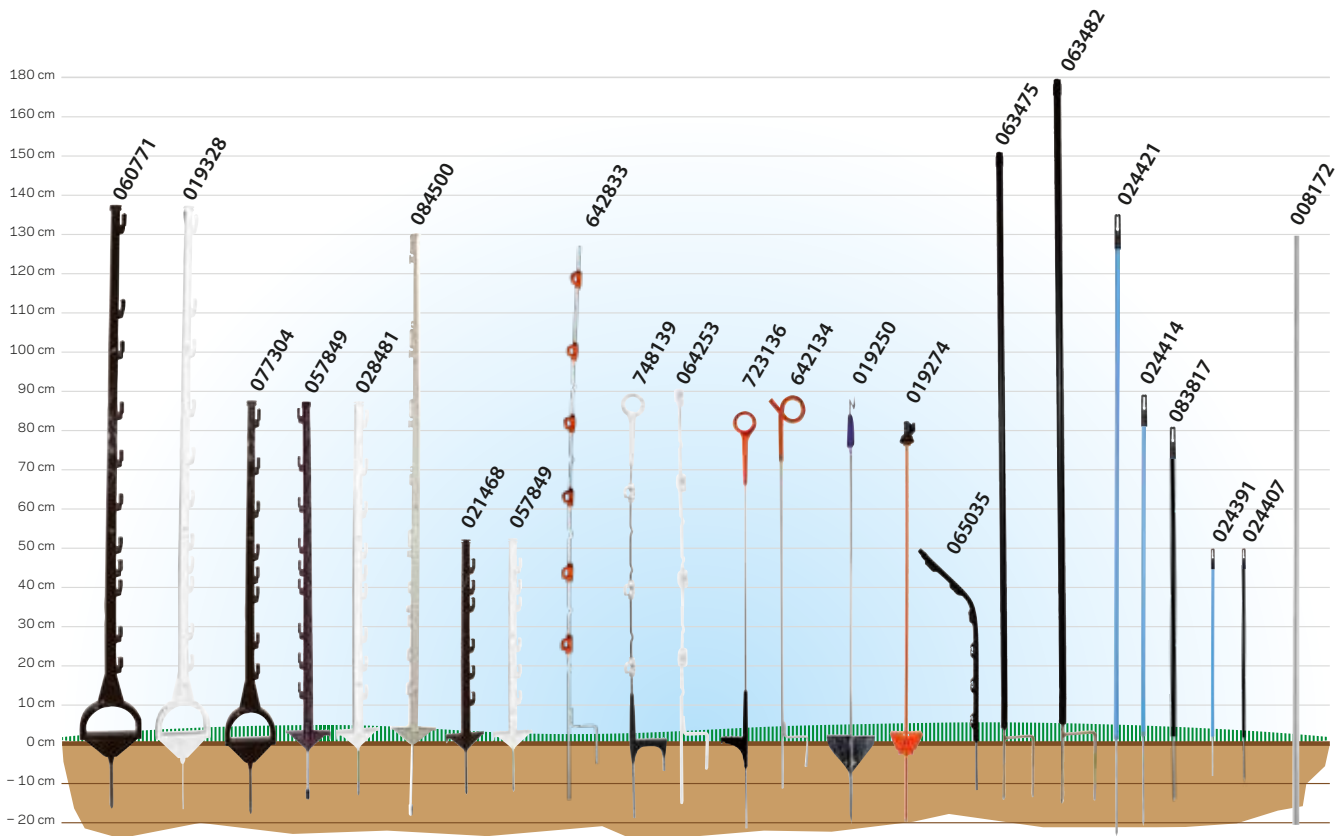

Horse post



Unique and durable post, 1,55 m high, which is ideal for semi-permanent horse fencing. Easy to tread by using the convenient stirrup foot. The unique twist 'n lock system guarantees a simple and secure attachment of the conductors up to 1,35 m high.

061303	Duopack Horse post white 1,55m (2x5)	10
061310	Duopack Horse post terra 1,55m (2x5)	10
019328	Horse post white 1,55m	5
060771	Horse post terra 1,55m	5
077304	Horse post terra 1,05m	10

PROMOTION
PROMOTION



Duopack Vario post



Very sturdy and durable plastic post 1,00 m high with 9 numbered lugs designed for virtually all kinds of animals. Suitable for all sorts of (poly)wire and tape up to 20 mm. The unique twist 'n lock system guarantees a simple and secure attachment of the conductors with a maximum wire height of 0,85 m.

069330	Duopack Vario post white 1,00m (2x10)	20
072507	Duopack Vario post terra 1,00m (2x10)	20
028481	Vario post white 1,00m	10
071043	Vario post terra 1,00m	10

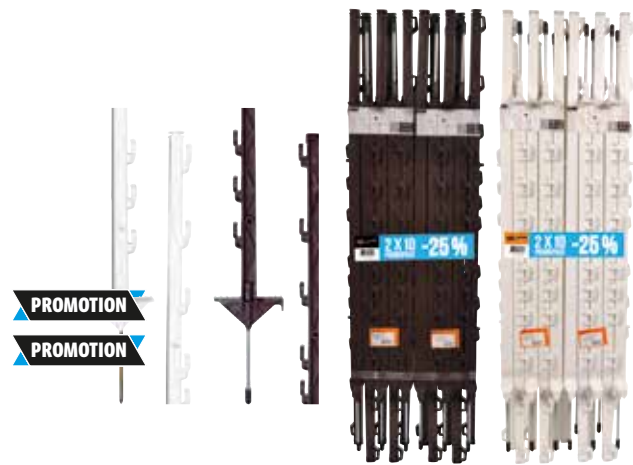

Plastic Wolf post 1,55m, white (10)



White plastic post with a total length of 1.55 m, with a maximum fencing height of 1.30 m. This post has 14 offsets that enable you to adjust the wire height and the number of wires to your needs. Suitable for plastic wire, cord and tape of up to 40 mm. Twist & lock system guarantees simple fixing.



084500	Plastic Wolf post 1,55m, white	10
--------	--------------------------------	----

Hobby post



Very sturdy and durable post, 0,75 m high, with 6 numbered lugs and extra strong footing. Suitable for tape up to 20 mm, rope and polywire. The unique twist 'n lock system guarantees a simple and secure attachment of the conductors with a maximum wire height of 50 cm.

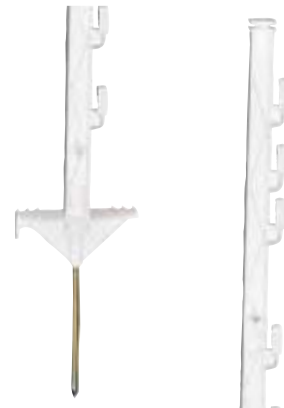

057849	Hobby post white 0,75m	10
021468	Hobby post terra 0,75m	10

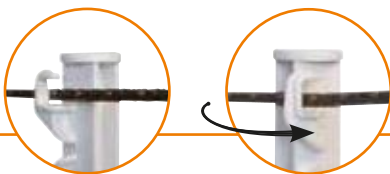

The unique Twist & Lock system ensures easy and stable connection of your conductors. With this system you can fit the conductors with one twist of your hand!

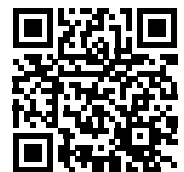

Multi wire post



Multi-wire post with adjustable clip heights. This post is ideal for a wide variety of uses with adjustable clips making it easy to build a multi-wire ringtop post

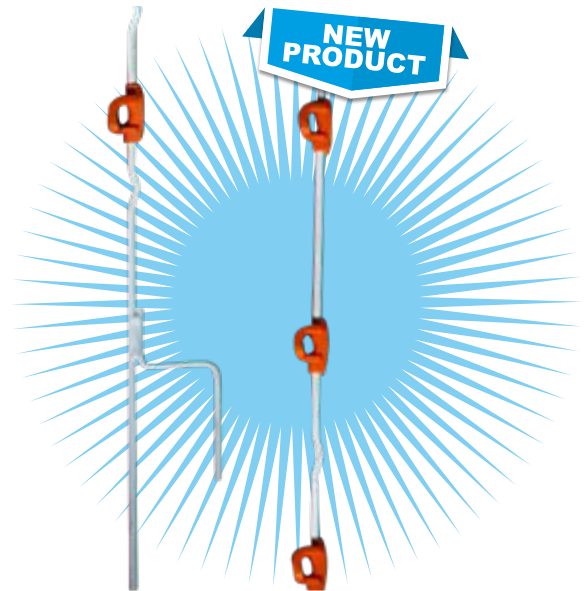

642833 Multi wire post white 1,50m 10

Multi wire Ring Top post



The Multi wire Ring Top Post has several movable insulators, making it easy to put up fencing at the required height. Extremely suitable for fencing pastures with animals of different heights. The post has a patented top insulator that prevents the wire from wearing through. Equipped with sturdy base plate and double ground spike. Gallagher Twist & Lock system.



748139 Multi wire Ring Top post white 1,10m 10

086276 Multi wire post Insulator White 20

086283 Multi wire post Insulator Orange 50

Multi wire Quattro post



Very sturdy, lightweight spring steel post with 4 removable insulators. Maximum fence height 87,5 cm. The 10 cm double pointed foot makes it easy to install. White insulated coating for maximum visibility and to avoid shorting problems.



064253 Multi wire Quattro post 1,00m 10

086276 Multi wire post Insulator White 20

086283 Multi wire post Insulator Orange 50

Ring Top post



The most popular option for dairy and beef cattle. Stronger through the use of glass-filled nylon, so that no wear occurs. More ergonomic due to the wide base and wire holder that does not get entangled when a bundle is carried. More durable due to UV protection and the use of high-quality nylon and galvanized post. Max. fence height 0.80 m.



723136 Ring Top post 1,00m 10

Pigtail post



Plastic coated spring steel post with UV stabilised plastic insulated orange pigtail insulator. If several wires are to be used, add screw-on insulator part no. 010950/010943. Maximum fence height: 0,85 m.



642134	Orange Pigtail post 1,00m	🔌 10
010950	Screw-on rod insulator black for post 4/10mm (20)	🔌 20
010943	Screw-on rod Insulator white for post 6/14mm (10)	🔌 10
010936	Screw-on rod Insulator green for post 8,5/13mm (20)	🔌 20

Spring steel pigtail post



Strong mild-steel post with blue top-insulator and large welded-on foot for easy tread-in installation. Use part 010950 if you want to add more wires (polywire and cord). Maximum fence height: 0,88 m.



019250	Spring steel Pigtail post 1,10m	🔌 10
010950	Screw-on rod insulator black for post 4/10mm (20)	🔌 20
010943	Screw-on rod Insulator white for post 6/14mm (10)	🔌 10
010936	Screw-on rod Insulator green for post 8,5/13mm (20)	🔌 20

Spring steel post

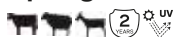

Spring steel fence post for a mobile fence. With solid plastic top insulator. Including foot for secure mounting in the ground. For use in combination with 12,5 mm tape, cord or plastic wire. Installing multiple wires using the adjustable insulator (010752). Maximum fence height: 0,80 m. Product warranty: 2 years.



019274	Spring steel post 1,00m	🔌 50
008902	Spring steel post 1,00m	🔌 1
010752	Click-on insulator for Spring steel post	🔌 10
009411	Topinsulator for Spring steel post	🔌 5

010950	Screw-on rod insulator black for post 4/10mm (20)	🔌 20
010943	Screw-on rod Insulator white for post 6/14mm (10)	🔌 10
010936	Screw-on rod Insulator green for post 8,5/13mm (20)	🔌 20

For more information and prices go to our website

www.gallagher.eu



Garden/Pond post



Compact, curved plastic post for mobile fences for deterring herons. Ideal for use near a pond. With curve as extra protection against animals leaning over and overhanging plants. For use in combination with plastic wire. Easy to fit. Maximum fence height: 51cm. Also suited to mount on a wooden fence to keep in/out animals (third party fittings required). Product warranty: 2 years.



065035 Garden/Pond post black 0,50m 5

Plastic post



Simple solid post for mobile fences to 1,50 m (# 063475) or 1,80 m (# 063482). Wire clips # 063499 to assemble at any desired height. Top insulator is removable so clips can easily be added.



063482 Plastic post black 19mm 2,00m 10

063475 Plastic post black 19mm 1,70m 10

063499 Stainless steel Clips for Plastic post 19mm 25

Plastic post



Plastic post for a mobile fence. Light and easy to install. With impact-resistant top insulator. For use in combination with plastic wire. Installing multiple wires using an adjustable spring (003266) or screw insulator (004218). Maximum fence height 1,35 m. Product warranty: 2 years.



024421 Plastic post blue 13mm 1,50m 10

024414 Plastic post blue 13mm 1,00m 10

024391 Plastic post blue 13mm 0,70m 10

024407 Plastic post black 13mm 0,70m 10

083817 Plastic post black 13mm 0,98m 10

003266 Stainless steel Clip for Plastic post 13mm 10

2211 Topinsulator Plastic post 13mm 1

Fibreglass post



Fibreglass post ø10mm for semi-permanent fences. Ideal in combination with polywire or 1,6mm High Tensile wire. Please use fibreglass clip 018300 (25) as wireholders. Maximum fence height: 1,30 m. Product warranty: 2 years.



008172 Fibreglass post white 10mm 1,50m 1

008158 Fibreglass post white 10mm 1,25m 50

018300 Stainless steel Clip for Fibreglass post 10mm 25

010950 Screw-on rod insulator black for post 4/10mm (20) 20

010943 Screw-on rod Insulator white for post 6/14mm (10) 10

010936 Screw-on rod Insulator green for post 8,5/13mm (20) 20

Tumble wheel



One person can move a whole fence within a matter of minutes using the tumble wheels. The strip grazing system reduces the grazing cycles and increases the yield. Ask your dealer for more information. Maximum fence height: 0.78 m. Spacing max. 25 meters.

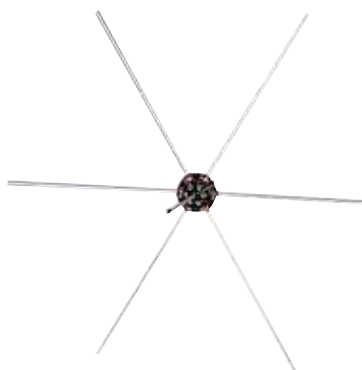

056388 Tumble Wheel 5



The SmartFence is the ideal portable fencing, and the perfect alternative to standard fence netting. The posts, reels and wires are combined into one system, ensuring you can put up a fence in no time. You can connect several SmartFences together and there is extremely good conductivity with a turbo conductor. The posts are flexible in use, so any shape of fencing can be achieved. The SmartFence consists of 10 posts and 4 wires that are height adjustable. The SmartFence can be assembled and dismantled extremely quickly and easily. A true all-in-1 patented Gallagher system.



SmartFence 2.0



Now you can install a mobile fence in no time. With the SmartFence you can build and dismantle the fence within 5 minutes. It is an all-in-one system of posts, wire and reels. The posts have a reinforced base which makes them easy to put in the ground. The fence can be placed in any desired shape by the flexible posts. In addition, the wires are adjustable in height. Easy to connect multiple smart fences together. Total length 100 m - 10 posts, 4 wires.



Fast:
Large reels ensure few windings when winding wire.



Easy to use:
Even a knot in the wire is no problem when winding in the reel.

700007	SmartFence 2.0	☞ 1
700045	SmartFence 2.0	☞ 4
9976	Hub reel with poly wire 102m (1,6mm)	☞ 1
9977	Hub reel with turbo wire 102m (1,6mm)	☞ 1

When you're putting up portable fencing, you cannot do without a reel. A reel is for rolling up and unrolling your wire. When you have unrolled the wire from the reel, you connect the reel to a reel post. The blocking catch ensures you can tension the wire. For removing or moving your portable fencing, you simply roll up the wire onto the reel. With a geared reel, rolling up the wire is 3x faster. Our Gallagher geared reels are unique with an ergonomic handle for extra grip and extra protection for your hand. These reels also have a click system, making them easy and quick to attach to a reel post or a vehicle, such as a quad.



Triple geared reel stand with wire pre-installed



Triple Geared Reel Stand with 400 m Vidoflex polywire. Pre-assembled with post and three pre-wound geared reels (061139). Post height 1070 mm and reels are pre-wound with 400 m Vidoflex polywire. Multi reel connector (006345) available separately.

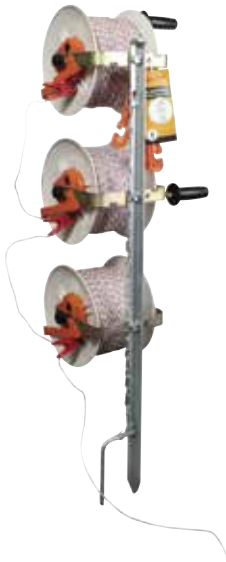

633046 Triple geared reel stand with wire pre-installed 1

Reel/Termination post



This reel corner post can be used together with a maximum of 5 reels or insulators. In combination with the insulators, this reel corner post is perfect as the start or end post of portable fencing. In combination with the reels it is really easy to put up portable fencing. The reel corner post is made of galvanised steel. Other accessories, other than insulators, have to be ordered separately. The maximum fence height is 1,50 m. Product warranty: 2 years.



081967	Reel/Termination post fits 5 Reels/5 Insulators 2,00m	1
022014	Reel/Termination post fits 3 Reels/3 Insulators 1,25m	1
082766	Reel/Termination post Reel bracket	5
022205	Reel/Termination post Support bracket	1
006345	Multi reel connector set	1

Geared reel pre-installed Polywire 500m

2

Reel with gear mechanism. Large handle with knuckle guard. Includes 500 m polywire. Can be easily mounted to the corner reel posts. Dual purpose portable handle included.



PROMOTION

061184 Geared reel pre-installed Polywire 500m 1

Large geared reel 1200m

2

Heavy duty gearbox for easy winding, fast wind in (2.7:1). Large comfortable hand grip with knuckle guard for safer use. Holds: 400 m 12,5 mm TurboLine tape, 400 m 12,5mm PowerLine tape, 1000 m Vidoflex 9 or 1200 m Vidoflex 6.



016313 Geared reel large 1200m 1

Geared reel 500m

2

Equipped with an accelerator mechanism so the drum rotates three times faster than standard reels. Carry handle with knuckle guard. Locking ratchet. Long crank arm for better leverage. Wire loop for connecting power to wire/tape. Holds up to 500 metres of polywire or 200 metres of tape/cord. Attachable to Reel/Termination post (#081967/#022014).



061139 Geared reel 500m 1

Medium reel 500m

2

Strong reel. For up to 500 m of polywire or 200 m of tape/cord. Including locking catch and ergonomically insulated handle. Fast wind up due to extra large inner diameter. Attachable to Reel/Termination post (#081967/#022014). Product warranty: 2 years.



061115 Medium reel 500m 1

Econoreel 500m

2

A strong and durable reel with ratchet mechanism for winding up and unwinding polywire. Suitable for up to 500m polywire. Equipped with insulated handle. Hooks directly to fence or use Reel Stand.



046167 Econo reel 500m 1

Reel 400m

2

Convenient plastic reel with ratchet for 400 metres of polywire. Detachable drum.



008919 Reel 400m 1

009145 Spare drum for Reel 400m 1

Reel 200m

2

Low cost convenient plastic reel with ratchet for 200 metres of polywire.



008933 Reel 200m 1

The conducting wire in electric fencing is of crucial importance, because it transports the current. Even though all conducting wires would appear to be the same, there is a big difference in terms of price and quality. There are also differences in use. The Gallagher range consists of tape, cord, plastic wire, Equifence and High Tensile. Each of them with their different conductivity, durability and design. Make sure you choose the right conducting wire for your use!



ElectroMax wire



ElectroMax of Gallagher: 15% more conductive than standard 2,5 mm high tensile wire. Carries power further and handles shorts better. Patented zinc-alu alloy outer surface for up to 3 times longer life than standard high tensile wire.

069385	ElectroMax wire 2,65mm - 26kg - 600m	🌀 1
036257	Tension spring for 2,5mm/2,65mm HT/EQ wire	🌀 1
021475	Wire tensioner	🌀 25
010882	Wire tensioner	🌀 3
743134	Insulated End Strainer	🌀 20
618005	Insulated End Strainer fastening cable	🌀 2
086337	Fence Wire Joiner	🌀 5

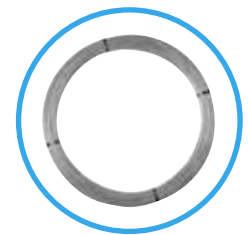

Zinc-alu-mag wire



Steel cored, high tensile fence wire for long cattle and sheep fencing. With an aluminium coating for longer life and greater conductivity. Lifespan: up to 30 years.

039999	HT zinc-alu-mag wire 2,5mm - 25kg - 625m	🌀 1
077311	HT zinc-alu-mag wire 1,8mm - 25kg - 1250m	🌀 1
004188	HT zinc-alu-mag wire 1,6mm - 25kg - 1580m	🌀 1
004195	HT zinc-alu-mag wire 1,6mm - 5kg - 315m	🌀 1
036257	Tension spring for 2,5mm/2,65mm HT/EQ wire	🌀 1
004133	Tension spring for 1,6mm/1,8mm wire	🌀 1

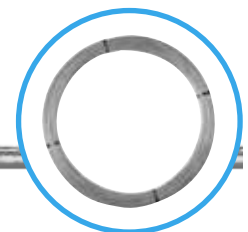

021475	Wire tensioner	🌀 25
010882	Wire tensioner	🌀 3
743134	Insulated End Strainer	🌀 20
618005	Insulated End Strainer fastening cable	🌀 2
086337	Fence Wire Joiner	🌀 5

Zinc-alu-mag wire



Erecting a permanent fence becomes very simple with this aluminised fencing wire. Easier to bend than regular HT wire, but strong enough to keep sheep, cattle or game in/out. Very low resistance, which makes this wire ideal for long fence lines.

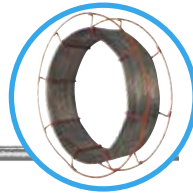

060412	MT zinc-alu-mag wire 1,8mm - 10kg - 500m	☞ 1
036257	Tension spring for 2,5mm/2,65mm HT/EQ wire	☞ 1
021475	Wire tensioner	☞ 25
010882	Wire tensioner	☞ 3
743134	Insulated End Strainer	☞ 20
618005	Insulated End Strainer fastening cable	☞ 2
086337	Fence Wire Joiner	☞ 5

TurboStar Equifence



A Gallagher premium product, with a number of unique properties and superior conductivity. Consists of a metal core with a UV-resistant coating on the outside. This coating makes the wire enormously strong, but soft when a horse comes into contact with it accidentally. TurboStar Equiwire contains 33% more conductive material than the current Equiwire. (We recommend installation by a specialist fence builder.)



912042	TurboStar Equifence white 250m	☞ 1
912240	TurboStar Equifence terra 250m	☞ 1
036257	Tension spring for 2,5mm/2,65mm HT/EQ wire	☞ 1
021475	Wire tensioner	☞ 25

010882	Wire tensioner	☞ 3
743134	Insulated End Strainer	☞ 20
618005	Insulated End Strainer fastening cable	☞ 2
086337	Fence Wire Joiner	☞ 5

Equifence



The safest solution for your horse. Unique electrically conductive polymer (in black stripes) provide excellent conductivity. Very safe and clearly visible due to the thick, smooth plastic cable (minimal risk of injury to your horse). Total diameter of 7,5 mm with a core of 2,5 mm high tensile wire. Environmentally friendly. Product warranty: 10 years. Lifespan: up to 30 years. We recommend installation by a specialist fence builder.

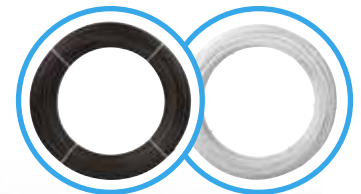

009124	Equifence white 7,5mm - 20kg - 250m	☞ 1
053858	Equifence terra 7,5mm - 20kg - 250m	☞ 1
036257	Tension spring for 2,5mm/2,65mm HT/EQ wire	☞ 1
021475	Wire tensioner	☞ 25

010882	Wire tensioner	☞ 3
743134	Insulated End Strainer	☞ 20
618005	Insulated End Strainer fastening cable	☞ 2
086337	Fence Wire Joiner	☞ 5

Stranded wire



High conductive 7 strand galvanised wire for very long, movable fences. Suitable for goats / sheep as well as cows and game. Product warranty: 2 years. Especially effective for fences with a lot of vegetation.

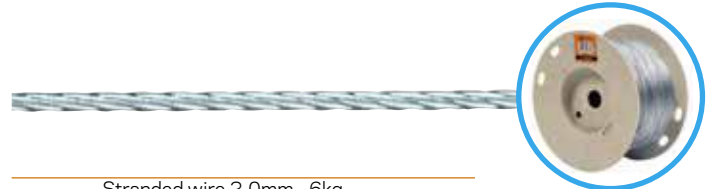

007806	Stranded wire 2,0mm - 6kg - 400m	☞ 1
008759	Stranded wire 2,0mm - 3kg - 200m	☞ 1
086337	Fence Wire Joiner	☞ 5

Gallagher has wide range of netting for ideal and reliable portable/moveable fencing. Whether you need netting for sheep, chickens, rabbits, cats, dogs or goats, we've got it. We would also like to introduce you to our ideal fencing for sheep and cattle. The SmartFence 2.0 is our pride and joy - the perfect alternative to standard fencing netting.



Netting key

We have a wide range of netting. Please use the key to find the right netting for you. It enables you to find the specifications of the netting.

For example:

Orange 90 / 1 W 14 / G 50 m

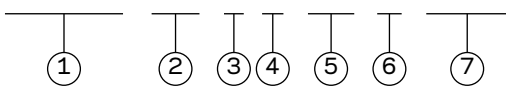

- 1 the colour of the netting
- 2 the height of the netting (cm)
- 3 1= single pin
2 = double pin
- 4 with a reinforced bottom wire
- 5 the number of posts
- 6 the colour of the posts: G=green / W=white / B=black
- 7 length of netting

EuroNetz Sheep netting



Complete and easy to use portable netting for sheep and lambs. If the pasture is bordered with ditches, netting offers even the newborn lambs maximum safety. Length: 50 m. It is easy to connect nets together. Repair kit included.

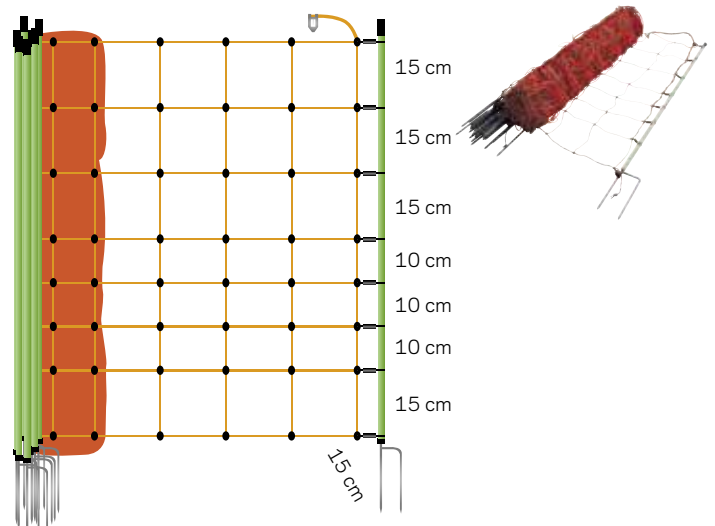

022175 EuroNetz Sheep netting, Orange 90/2-14/G-50m 1

EuroNetz Sheep netting



Complete and easy to use portable netting for sheep and lambs. If the pasture is bordered with ditches, netting offers even the newborn lambs maximum safety. Length: 50m. It is easy to connect nets together.

022106 EuroNetz Sheep netting, Orange 90/1-14/G-50m 1

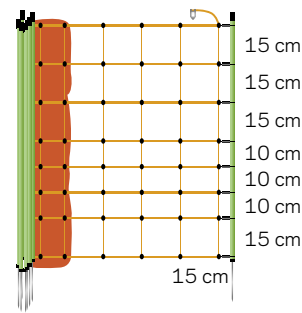

EuroNetz Sheep netting



Complete and easy to use portable netting for sheep and lambs. If the pasture is bordered with ditches, netting offers even the newborn lambs maximum safety. The bottom wire is extra reinforced. The length of this netting is 50m and includes 14 posts with double pin, which have been incorporated into the netting.

075768 EuroNetz Sheep netting, Orange 90/2W14/G-50m 1

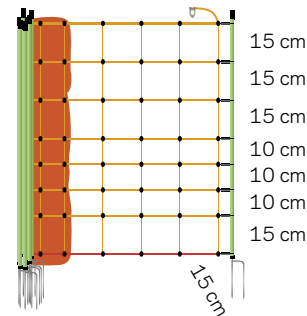

EuroNetz Sheep netting



Complete and user-friendly fencing netting for sheep and lambs that is easy to move. This netting is also suitable as fencing near ditches so new-born lambs can stay in the pasture in complete safety. The netting includes 14 posts with double pin, which have been incorporated into the netting, and it is 50m long. Several nets are easy to connect together.

075386 EuroNetz Sheep netting, Orange 90/2-14/W-50m 1

075379 EuroNetz Sheep netting, Orange 90/1-14/W-50m 1

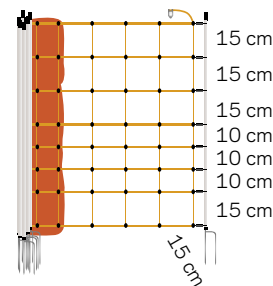

Sheep netting



Complete and easy to use portable netting for sheep and lambs. If the pasture is bordered with ditches. Length: 50m. Includes 14 double spike installed in the netting.

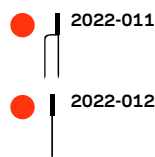
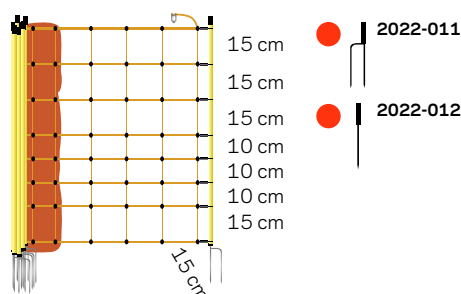

086252 Sheep Netting, Orange 90/2-14/Y-50m 1

086269 Sheep Netting, Orange 90/1-14/Y-50m 1



EuroNetz Goat netting



Complete and easy to use portable netting for goats and lambs. If the pasture is bordered with ditches, netting offers even the newborn lambs maximum safety. Length: 50m. It is easy to connect nets together.

022212	EuroNetz Goat netting, Orange 105/2-14/G-50m	1
022168	EuroNetz Goat netting, Orange 105/1-14/G-50m	1

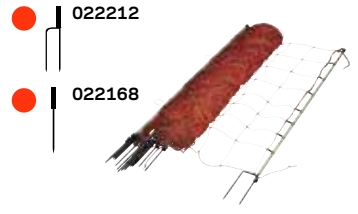
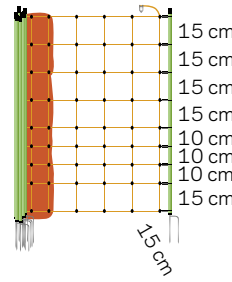

EuroNetz Rabbit netting/Hobby netting



Fencing netting for rabbits and other small pets. Can also be used for an allotment or a field. Complete and easy to attach to several other nets. Length 25m, 9 posts.

077281	EuroNetz Rabbit-/hobby netting, Green 65/1-9/B-25m	1
022182	EuroNetz Rabbit-/hobby netting, Orange 65/1-15/G-50m	1
024377	EuroNetz Rabbit-/hobby netting, Green 65/1-15/B-50m	1

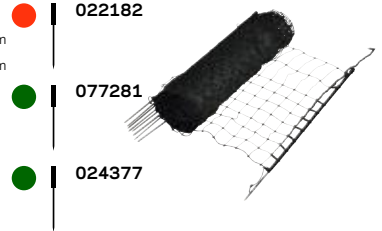
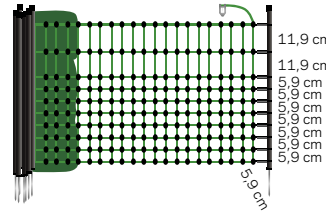

Hobby netting



Non-electric hobby netting. Ideal as a temporary solution for your dog, for example en route or on holiday. Easy to carry and easy to install.

086245	Hobby netting, Green 65/1-5/B-15m	1
--------	--------------------------------------	---

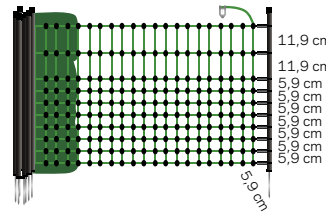

EuroNetz Poultry netting



Fencing netting for chickens and poultry. Complete and easy to attach to several other nets. Length 25m, 9 posts.

077298	EuroNetz Poultry netting, Green 112/1-9/B-25m	1
022403	EuroNetz Poultry netting, Orange 112/2-15/G-50m	1
022229	EuroNetz Poultry netting, Orange 112/1-15/G-50m	1
076833	EuroNetz Poultry netting, Green 112/2-15/B-50m	1
075867	EuroNetz Poultry netting, Green 112/1-15/B-50m	1

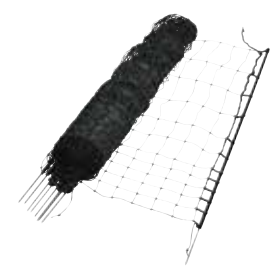
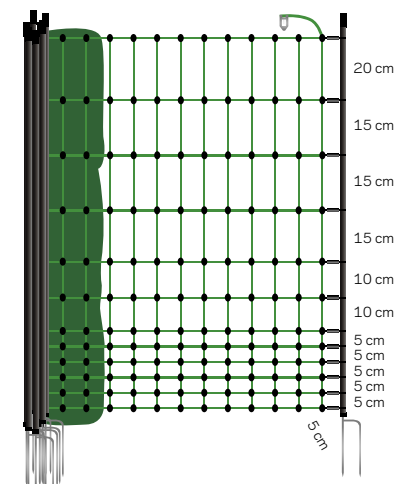

Wolf netting, Blue



Protect your animals against wolves with this compact wolf netting. Post length is 1,20m and easy to handle. The netting has a 25mm top insulator for possibly adding blue signal tape. The netting is easy to connect together. With an extra reinforced, non-conductive bottom wire.

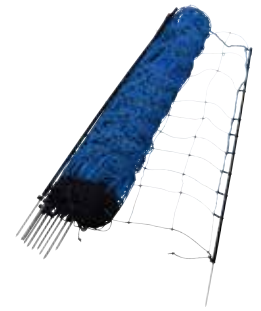
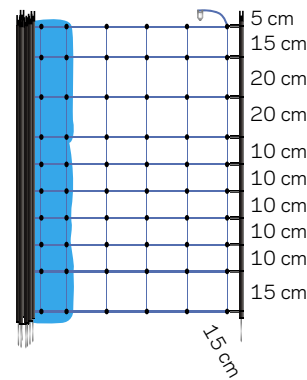

083039 Wolf netting, Blue 120/1W14/B-50m 1

EuroNetz Wolf netting



Complete and user-friendly fencing netting to keep out wolves. The netting is 50m long and is 1.20m high. It has 14 posts with a double pin and a reinforced bottom wire to prevent it from being breached by gnawing or chewing. The netting is easy to erect and several nets can be linked together.

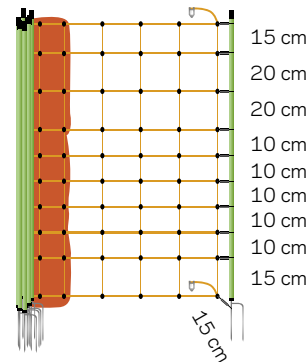

078677 EuroNetz Wolf netting, Orange 120/2W14/G-50m 1

EuroNetz Wolf netting



Fencing netting to protect your animals against wolves, with a plus/min connection. This means that the wires are connected alternately to the plus and minus pole of the energizer. If 2 wires are touched at the same time, the animal experiences a strong, brief shock. This system guarantees full voltage, even on surfaces where earthing is tricky. The netting has 14 posts with a double pin, it is 1.20m high, 50m long and extremely easy to use.

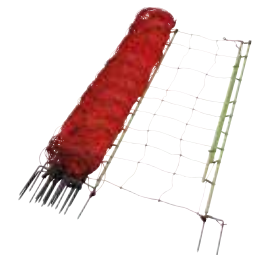
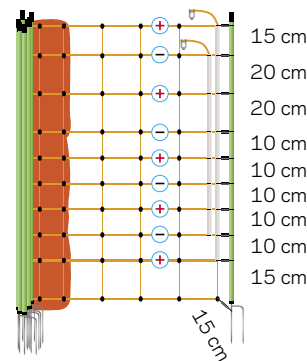

078684 EuroNetz Wolf netting, Orange 120/2W14/G-pos/neg-50m 1

EuroNetz Wild boar netting



Turbo netting against wild boars. Strong posts 19mm, best solution to prevent wild boars destroying your crops. An electric fence in combination with a budget physical barrier.

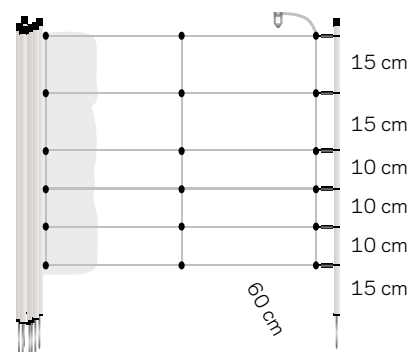

062973 EuroNetz Wild boar netting, White 75/1-14/W-50m 1

EuroNetz Turbo netting



Strong, high quality Turbo netting. With a stranded cord, which re-reinforces the top wire by 80%, for greater conductivity.

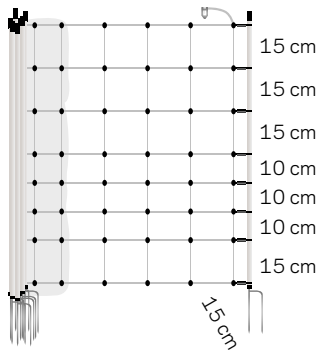

● 025473

● 010493

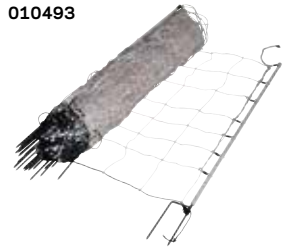

025473	EuroNetz Turbo netting, White 90/2-14/W-50m	☒ 1
010493	EuroNetz Turbo netting, White 90/1-14/W-50m	☒ 1

EuroNetz Combo netting



This netting is extremely suitable for uneven terrain with sheep and goats. The netting is 50m long. The plastic reinforcement of the vertical wires, every 30cm, ensures this netting is always tight. The netting includes 14 posts with double pin, which have been incorporated into the netting.

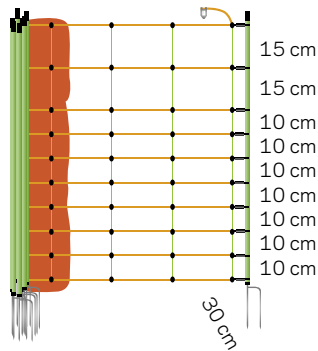

● 075584

● 010356



075584	EuroNetz Combo netting, Orange 90/2-14/G-50m	☒ 1
010356	EuroNetz Combo netting, Orange 90/1-14/G-50m	☒ 1

EuroNetz Combo netting



Combo netting: the netting with extra stability for use on rocky territory. Every 30cm the vertical wires are reinforced, resulting in a tighter net in rough terrain.

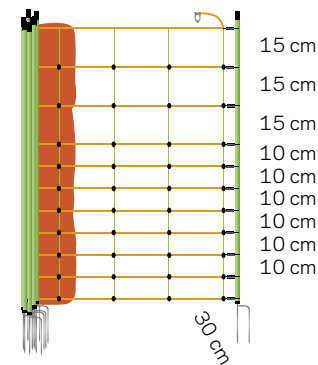

● 075539

● 072415



075539	EuroNetz Combo netting, Orange 105/2W14/G-50m	☒ 1
072415	EuroNetz Combo netting, Orange 105/1W14/G-50m	☒ 1

EuroNetz Gate for electric netting



A gate set for convenient opening or closing of net fencing. Easy to use and to connect to your net fencing.

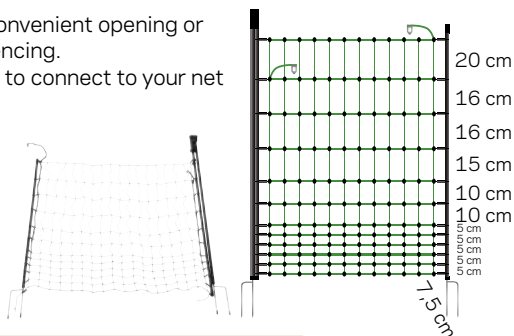

079360	Entry gate for EuroNetz electric netting (120x100cm)	☒ 1
--------	--	-----

EuroNetz repair set

Repair Set Euro Netting



22104	EuroNetz Repair Set Euro and Combo netting	☒ 1
-------	--	-----

The Gallagher tape conductors are super strong, highly visible and provide the best possible power guarantee. Our Turbostar tape conductors are unique with a reinforced top and bottom. Most tape conductors do not give a shock when the animal touches the bottom of the tape, but Turbostar tape conducts power through the reinforced top and bottom. The Turbostar and Turboline tape conductors are suitable for longer fences. Always go for a Turbo conductor when the fencing is longer than 500 metres. With a long UV guarantee (see label) that guarantees you a durable product.

Use our blue Powerline tape conductor to keep wild animals away from yours. The colour blue is particularly visible to wild animals.

All Gallagher tape conductors are made of the highest quality and will keep your animals safely inside or outside your fence.

Vidoflex 12 TurboLine Plus



The most conductive TurboLine Plus poly wire -3,0 mm- for portable fencing. The 6 stainless-steel wires and 4 galvanised copper wires conduct 80 times better than a standard poly wire. This TurboLine Plus model is 50% stronger, does not stretch and is even more clearly visible. Available in white. It has a 5-year UV warranty.

079377	Vidoflex 12 TurboLine Plus White 400m	1
060764	Vidoflex connector	4



Vidoflex 9 TurboLine Plus



52% stronger than traditional polywire. Will not twist or kink when winding onto reels. Ideal for long portable fences, the patented mixed metal conductive wires carry the pulse 40 times better than standard PowerLine wire. Always use TurboLine products if fence > 500 m. UV-warranty: 5 years.

049028	Vidoflex 9 TurboLine Plus White 1000m	1
075775	Vidoflex 9 TurboLine Plus Terra 1000m	1
086290	Vidoflex 9 TurboLine Plus Blue 1000m	1
011254	Vidoflex 9 TurboLine Plus White 400m	1
054862	Vidoflex 9 TurboLine Plus Terra 400m	1
011247	Vidoflex 9 TurboLine Plus White 200m	1
079421	Duopack Vidoflex 9 TurboLine Plus White 2x1000m	2
086436	Duopack Vidoflex 9 TurboLine Plus Terra 2x1000m	2
069323	Duopack Vidoflex 9 TurboLine Plus White 2x400m	2
086443	Duopack Vidoflex 9 TurboLine Plus Terra 2x400m	2
069316	Duopack Vidoflex 9 TurboLine Plus White 2x200m	2

PROMOTION

PROMOTION

PROMOTION

PROMOTION

PROMOTION

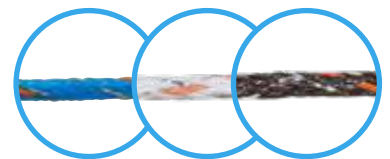

Vidoflex 6 PowerLine



Thick polywire with 6 stainless steel wires providing excellent conductivity. Ideal for portable fences < 500 m. UV stabilised and high tensile strength for longer life.



072422	Vidoflex 6 PowerLine White 1000m	1
021697	Vidoflex 6 PowerLine White 400m	1
054855	Vidoflex 6 PowerLine Terra 400m	1
021680	Vidoflex 6 PowerLine White 200m	1
063970	Vidoflex 6 PowerLine Terra 200m	1
060764	Vidoflex connector	4

Vidoflex 3 PowerLine



Polywire with 6 stainless steel wires. Suitable for short portable fences. Available in 100 m (brown #063987 & green #019335) and 200m (white #010554).



010554	Vidoflex 3 PowerLine White 200m	1
063987	Vidoflex 3 PowerLine Terra 100m	1
019335	Vidoflex 3 PowerLine Green 100m	1
060764	Vidoflex connector	4

TurboLine Blue Polywire



Blue polywire specially developed to keep wild animals out, in specific wild boars. Studies show that wild boars have poor eyesight and primarily see the color blue. Keep your crops safe by using this highly conductible wire.



079452	Duopack TurboLine Blue Polywire 2x400m	2
072477	TurboLine Blue Polywire 1000m	1
075829	TurboLine Blue Polywire 400m	1

PROMOTION

079384	TurboLine Blue Polywire 200m	1
060764	Vidoflex connector	4

TurboLine rope



The best rope conductor! Strong braided cord for optimal installation. For permanent horse and cow fencing. Also suitable for keeping game out. Power guaranteed from start to finish by additional conductive wires (3 tinned copper wires in combination with 8 stainless steel wires). Does not stretch. With extra UV protection. UV warranty: 7 years. Easy to install. For fences longer than 500 m.



058006	TurboLine rope braided White 500m	1
057993	TurboLine rope braided Terra 500m	1
057856	TurboLine rope braided White 200m	1
056101	TurboLine rope braided Terra 200m	1
071159	Rope connector	25
019342	Rope connector	4
075928	Rope connector with wingnut	4
028955	Rope tensioner	1

Duopack TurboLine rope



The best rope conductor! Strong braided cord for optimal installation. For permanent horse and cow fencing. Also suitable for keeping game out. Power guaranteed from start to finish by additional conductive wires (3 tinned copper wires in combination with 8 stainless steel wires). Does not stretch. With extra UV protection. UV warranty: 7 years. Easy to install. For fences longer than 500 m.



069798	Duopack TurboLine rope braided White 2x500m	2
069804	Duopack TurboLine rope braided Terra 2x500m	2
069293	Duopack TurboLine rope braided White 2x200m	2
069309	Duopack TurboLine rope braided Terra 2x200m	2
071159	Rope connector	25
019342	Rope connector	4
075928	Rope connector with wingnut	4
028955	Rope tensioner	1

PowerLine rope



Braided PowerLine Rope for semi-permanent horse and cattle fencing. Power guaranteed from start to finish by additional conductive wires. UV warranty: 5 years. Easy to install. For fences shorter than 500 m.



072453	PowerLine rope braided White 500m	1
072460	PowerLine rope braided Terra 500m	1
063956	PowerLine rope braided White 200m	1
063963	PowerLine rope braided Terra 200m	1
071159	Rope connector	25
019342	Rope connector	4
075928	Rope connector with wingnut	4
028955	Rope tensioner	1

EconomyLine rope



EconomyLine cord for temporary horse and cow fencing. Good conductivity. With extra UV protection. UV warranty: 3 years. Easy to install. For fences shorter than 500 m. Excellent price / quality ratio.



063932	EconomyLine rope White 500m	1
063925	EconomyLine rope White 200m	1
063949	EconomyLine rope Terra 200m	1
063918	EconomyLine rope White 100m	1
071159	Rope connector	25
019342	Rope connector	4
075928	Rope connector with wingnut	4
028955	Rope tensioner	1

TurboStar tape



TurboStar Tape is a premium 40 mm tape for long, permanent horse fencing. Perfectly visible. Extra strong due to sturdy, conductive thread in the edges. Power guaranteed from start to finish by excellent conductivity. The unique composition provides 40x better conductivity than standard 40 mm tape. UV warranty: 7 years. For fencing longer than 500 m. Recommended by horse owners!



070862	TurboStar tape 40mm White 350m	1
070879	TurboStar tape 40mm Terra 350m	1
010608	TurboStar tape 40mm White 200m	1
010615	TurboStar tape 40mm Terra 200m	1
010516	TurboStar tape 40mm Green 200m	1

072439	TurboStar tape 40mm White 100m	1
072446	TurboStar tape 40mm Terra 100m	1
028962	Tape joiner 20/40mm	5
010745	Tape joiner 20/40mm	5
055333	Tape connector tape/tape 60cm	1

TurboLine tape



TurboLine Tape is a premium 40 mm tape for long, permanent horse fencing. Perfectly visible. Extra strong due to sturdy, conductive thread in the edges. Power guaranteed from start to finish by excellent conductivity. The unique composition provides 40x better conductivity than standard 40 mm tape. UV warranty: 7 years. For fencing longer than 500 m. Recommended by horse owners!



PROMOTION

007592	TurboLine tape 40mm White 200m	1
028962	Tape joiner 20/40mm	5

010745	Tape joiner 20/40mm	5
055333	Tape connector tape/tape 60cm	1

TurboLine tape



Very strong TurboLine Tape for semi-permanent fences. With reinforced red edges. Power guaranteed from start to finish due to excellent conductive properties. The unique composition (3thick stainless steel wires and 2 light metal wires)) provides 40x more conductivity than standard Powerline tape. UV warranty: 5 years. Always use TurboLine products if fence > 500 m.

007608	TurboLine tape 20mm White 200m	1
060702	TurboLine tape 20mm Terra 200m	1
086306	TurboLine tape 20mm Blue 200m	1



PROMOTION

028962	Tape joiner 20/40mm	5
010745	Tape joiner 20/40mm	5

TurboLine tape



12,5 mm TurboLine Tape. With re-inforced edges and 40 times more conductive than standard polytape. Ideal for portable electric fences. Available in 200 m and 400 m rolls. Always use TurboLine tape if fence > 500 m.

079438	Duopack TurboLine tape 12,5mm White 2x400m	2
079445	Duopack TurboLine tape 12,5mm White 2x200m	2
086231	TurboLine tape 12,5mm White 400m	1
076232	TurboLine tape 12,5mm White 200m	1



028979	Tape joiner 12,5/20mm	5
--------	-----------------------	---

TurboLine tape



12,5 mm TurboLine Tape. With re-inforced edges and 40 times more conductive than standard polytape. Ideal for portable electric fences. Available in 200 m and 400 m rolls. Always use TurboLine tape if fence > 500 m. The blue colour makes this tape particularly suitable for keeping game animals away from your own animals, because wild animals see the colour blue particularly well.

079391	TurboLine tape 12,5mm Blue 200m	1
028979	Tape joiner 12,5/20mm	5



PowerLine tape



Highly visible tape with black reinforced edges for semi-permanent horse fencing. 11 thick stainless steel wires and 1 mixed metal wire for excellent conductivity. UV warranty: 5 years. For fences shorter than 500 m.

006246	PowerLine tape 40mm White 200m	1
060696	PowerLine tape 40mm Terra 200m	1
028962	Tape joiner 20/40mm	5
010745	Tape joiner 20/40mm	5



PowerLine tape



Highly visible tape with black reinforced edges for semi-permanent horse fencing. 11 thick stainless steel wires and 1 mixed metal wire for excellent conductivity. UV warranty: 5 years. For fences shorter than 500 m.

106236	PowerLine tape 20mm White 200m	1
028962	Tape joiner 20/40mm	5
010745	Tape joiner 20/40mm	5



PowerLine tape



Highly visible tape with black reinforced edges for semi-permanent horse fencing. 11 thick stainless steel wires and 1 mixed metal wire for excellent conductivity. UV warranty: 5 years. For fences shorter than 500 m.

026237	PowerLine tape 12,5mm White 200m	1
062303	PowerLine tape 12,5mm White 100m	1
028962	Tape joiner 20/40mm	5
010745	Tape joiner 20/40mm	5



With our range of insulators we provide a solution for every type of fencing. Whether you use tape, cord, plastic wire, EquiFence or aluminium-coated wire, Gallagher has it all. Our insulators stand out in terms of price, quality and durability.



Wire clip insulator for Line Post



You need this wire clip if you want to fit fencing wire or cord of up to 8 mm (Gallagher EquiFence/permanent cable) to a Line Post. These clips have been developed especially for the Gallagher Line Post.



082285	Wire clip insulator for Gallagher Line Post	☞ 100
744346	Wire clip insulator for Gallagher Line Post	☞ 20

XDI screw-in insulator wood



Improved screw-in insulator with unique advantages over traditional black screwing insulators. Much stronger due to the new technology.



060788	XDI screw-in insulator	☞ 250
025527	XDI screw-in insulator	☞ 125
065059	XDI screw-in insulator	☞ 75
025510	XDI screw-in insulator	☞ 25
077397	Drill chuck Pro	☞ 1
086429	Drill chuck Metal	☞ 1

XDI bolt-on insulator M6x23mm metal

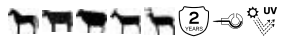

High quality Bolt-on insulator with metal core. The orange ring guarantees an equal distance between the insulator and the conductor. Suitable for (poly) wire or cord on a steel post, like the Termination post (022014/022236). (External thread length 25mm M6 incl. 2xnut, total length 33mm).



079094	XDI bolt-on insulator	🔌 125
057795	XDI bolt-on Insulator	🔌 10
086429	Drill chuck Metal	🔌 1

Screw-in insulator wood



Low-priced, high quality screw-in insulator without metal core. Suitable for wooden posts.



060894	Screw-in insulator Economy	🔌 75
077397	Drill chuck Pro	🔌 1
086429	Drill chuck Metal	🔌 1

Screw-in Insulator Promopack



With metal core. High-quality black plastic. For wooden posts. Suitable for (poly) wire and cord.



071074	Promopack 100x Screw-in Insulator in bag	🔌 100
077397	Drill chuck Pro	🔌 1
086429	Drill chuck Metal	🔌 1

Screw-in insulator wood small



Solid High quality screw-in insulator without metal core, therefore no short circuiting possible. For adding a wire to a wooden fence post.



011193	Screw-in insulator small	🔌 250
040711	screw-in insulator small	🔌 125
004089	Screw-in insulator small	🔌 25
077397	Drill chuck Pro	🔌 1
086429	Drill chuck Metal	🔌 1

Screw-in insulator wood Super



High quality screw-in ring insulator for wooden post. Suitable for wire. The super version (009008/011209/040728) is also suitable for 12,5 mm tape. Without a metal core, so no short circuiting possible. Product warranty: 2 years.



011209	Screw-in insulator super	🔌 250
040728	Screw-in insulator super	🔌 100
009008	Screw-in insulator super	🔌 25
077397	Drill chuck Pro	🔌 1
086429	Drill chuck Metal	🔌 1

W-insulator Small



Made from high density, sunlight resistant polyethylene plastic. Large heavy duty shield eliminates power leakage. Suitable for guiding wire around a corner post.



028498	W-insulator small black	🔌 175
006734	W-insulator small black	🔌 25
050000	Gallagher Screws 4,5x40 T25	🔌 200

W-insulator Super



Made from high density, sunlight resistant polyethylene plastic. Large heavy duty shield eliminates power leakage. Also suitable for guiding wire around a corner post.



067617	W-insulator super white	€ 175
021055	W-insulator super black	€ 175
067612	W-insulator super white	€ 25
067605	W-insulator super black	€ 25
050000	Gallagher Screws 4,5x40 T25	€ 200

High Strain insulator Kit with stainless steel rope



Simplest option for end strain insulation. Long life Super Strain Insulator with pre-attached stainless steel rope. Simple install, no wire tying or special tools required. Fits up to 200mm/8" pos



079483	High Strain insulator Kit white with stainless steel rope	€ 5
--------	---	-----

Strain insulator S



Suitable for short strains and semi-permanent short fences. Not suitable for high tensile. Productgarantie: 2 jaar.



012015	Strain insulator black	€ 100
011025	Strain insulator black	€ 5

Strain insulator S reinforced



Suitable for short strains and semi-permanent short fences. Suitable for HT wire. Available in black and white. Super strong due to polycarbonate version. Product warranty: 10 years.



012022	Strain insulator reinforced white	€ 100
678061	Strain insulator reinforced black	€ 100
011032	Strain insulator reinforced white	€ 5
678023	Strain insulator reinforced black	€ 5

Corner insulator Extra High Voltage



Designed for high powered fencing systems and areas where insulation is critical. Insulation ribs provide 2 x the insulation performance of previous models to reduce chances of stray voltage around critical areas. The streamlined design allows a comfortable positioning in hand during the installation. The wire can be easily cut away for product reuse.



100003	Corner insulator Extra High Voltage white	€ 100
100002	Corner insulator Extra High Voltage white	€ 10

For more information and prices go to our website

www.gallagher.eu



Porcelain strain/corner insulator



A porcelain corner insulator to strain the wires on the corner posts



- 053506** Porcelain strain/corner insulator 60
- 015139** Porcelain strain/corner insulator 6

Porcelain corner insulator



A porcelain End-strain Insulator for high tensions



- 015141** Porcelain corner insulator 60
- 015146** Porcelain corner insulator 6

Roller screw-in insulator



Innovative Gallagher design. Easy to install. Suitable for poly wire and rope. The special design means the wire always returns to the roll.



- 086313** Roller screw-in insulator 30
- 029013** Roller screw-in insulator 5

Roller bolt-on insulator

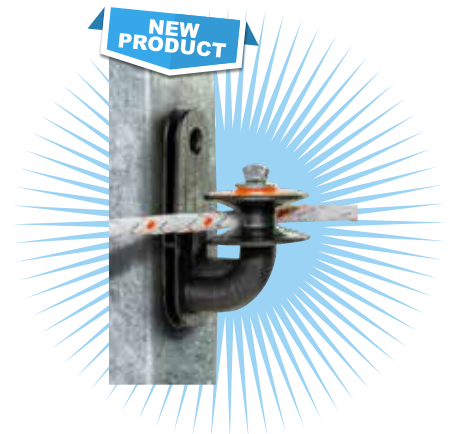

- 086528** Roller bolt-on insulator (5) 5

Rope tensioner



For easy tensioning of rope (not suitable for vidoflex). Easy release thumb catch. For use in combination with the roller screw-in insulator. (# 029013) or the strain insulator (# 011025/011032). Comes as standard with a roller screw-in insulator. Product warranty: 2 years.



- 028955** Rope tensioner 1

Clips Long for Insultimber/Ecopost



We recommend the use of Part.No 011056 for fixing wire to an Insultimber post or Gallagher Ecopost. Use Part.No 011063 with 1 metre droppers. You can tighten the clips using the wire twister (part.no 005232).



- 024704** Clips long for Insultimber/Ecopost 1000
- 011063** Clips long for Insultimber/Ecopost 50

Clips Short for Insultimber/Ecopost



We recommend the use of Part.No 011056 for fixing wire to an Insultimber post or Gallagher Ecopost. Use Part.No 011063 with 1 metre droppers. You can tighten the clips using the wire twister (Part.No 005232).

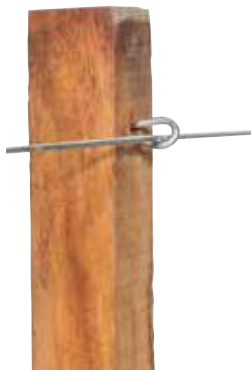

024698	Clips short for Insultimber/ Ecopost	📦 1000
011056	Clips short for Insultimber/ Ecopost	📦 25

TurboStar Horse corner/strain insulator



The new very innovative robust Corner Insulator. Has a lot of advantages compared to the traditional insulators. A unique sub frame for optimal strength and fixation at the post. Pre mounted rubber grip for best tape fixation. Can be installed with only one drill bit. A unique slot to strain and re-strain your tape. The optional metal plate (art. 708027) can be used as a tape connector and gate anchor.



701042	TurboStar Horse corner/strain Insulator	📦 30
701028	TurboStar Horse corner/strain insulator	📦 5

Connection plate/gate anchor



Connection plate goes together with our TurboStar corner tape insulator. Combination of tape connector makes interconnections and gate anchor. Gate anchor can be bended 90 degrees to achieve easy use.



708027	Connection plate TurboStar Horse corner/strain Insulator	📦 5
--------	--	-----

TurboLine corner/strain insulator



Specially designed corner insulator in high quality plastic which secures the tape between 2 rubber sleeves (patented system), guaranteeing long life for your tape. Use the stainless steel connecting plate (Part No. 010745) for end (gate) posts to ensure good connection between the tapes.

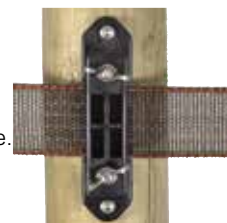

043880	TurboLine corner/strain insulator with wingnut	📦 30
016702	TurboLine corner/strain insulator with wingnut	📦 5

TurboStar Horse insulator



Insulator with two soft rubber clamps to hold the tape (patented system). Fixes the tape with 1 click and prevents wearing guaranteeing a long life for your tape. The screw in the middle of the insulator can be used to further tighten the tape. Product warranty: 10 years.



699066	TurboStar Horse insulator	📦 100
699004	TurboStar Horse insulator	📦 20

TurboLine tape insulator



Insulator with soft faces to lock the tape between two rubber sleeves (patented system) to prevent the wear off guaranteeing a long life for your tape.



021482	TurboLine Tape insulator	📦 100
011087	TurboLine Tape insulator	📦 20

TurboStar Line Post tape clip



You need this tape clip if you want to fit fencing tape of up to 40mm to a Line Post. It is easy to fit the tape; with one click the tape is clamped between the 2 rubber parts that you use to erect the fencing quickly and easily.



082278	TurboStar Tape clip insulator for Gallagher Line Post	📦 100
747033	TurboStar Tape clip insulator for Gallagher Line Post	📦 12

PowerLine tape insulator



Insulator used to fix 40mm tape to wooden fence post. Can be stapled, nailed or screwed to post. The tape is very easy to fix.

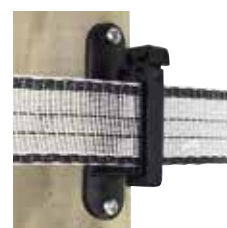

040674	PowerLine Tape insulator	📦 125
011094	PowerLine Tape insulator	📦 25

XDI offset screw-in insulator wood 18cm



Innovative Gallagher design. Much stronger than the standard offset screw-in insulator thanks to a new technique, and more durable thanks to its metal core. The orange plastic section serves as a wear indicator. Reduces the chance of short-circuiting. To be used with wooden posts. Distance 18 cm.



042647	XDI offset screw-in insulator 18cm	100
028993	XDI offset screw-in insulator 18cm	10

XDI offset screw-in insulator wood bended 18cm



Innovative Gallagher design. Much stronger than the standard offset screw-in insulator thanks to a new technique, and more durable thanks to its metal core. The orange plastic section serves as a wear indicator. Reduces the chance of short-circuiting. To be used with wooden posts.



057818	XDI offset screw-in insulator bended 18cm	100
057801	XDI offset screw-in insulator bended 18cm	10

XDI offset screw-in insulator wood 10cm



Innovative Gallagher design. Much stronger than the standard offset screw-in insulator thanks to a new technique, and more durable thanks to its metal core. The orange plastic section serves as a wear indicator. Reduces the chance of short-circuiting. To be used with wooden posts.



077274	XDI offset screw-in insulator 10cm	100
075904	XDI offset screw-in insulator 10cm	20

Offset screw-in insulator wood 10cm



Solid high quality offset screw-in insulator (10cm) for wooden posts. Without metal core. Suitable for (poly) wire and cord. Supplied with drill chuck.



082711	Offset screw-in insulator 10cm	90
072491	Offset screw-in insulator 10cm	20

Fence Insulator for pos/neg system



This insulator has been developed especially for fitting on an offset insulator (item 072491 or 029006). With this combination you can quickly and easily create a plus-minus fencing on your fence to keep cats out or in your garden.



077335	Fence Insulator for pos/neg system	30
--------	------------------------------------	----

XDI offset bolt-on insulator metal 20cm/M6



Innovative Gallagher design. Much stronger than the standard offset insulator due to a new technique, and more durable due to its metal core. The chance of short-circuits is zero. The orange plastic section serves as a wear indicator. (Total length 200 mm, external thread length 125 mm M6 incl. 2x nut/washer).



029006	XDI offset bolt-on insulator 20cm/M6	10
--------	--------------------------------------	----

XDI offset bolt-on insulator 10cm/M6



Innovative Gallagher design. Much stronger than the standard offset insulator due to a new technique, and more durable due to its metal core. The chance of short-circuits is zero. The orange plastic section serves as a wear indicator. (Total length 100 mm, external thread length 60mm M6 incl. 2x nut/washer).



086481 XDI offset bolt-on insulator 10cm/M6 10

Mounting bracket Premium 40/60mm



Mounting bracket Premium. Fits on every garden wire enclosure. Incl. a connection point suitable for M6 and M8 thread insulators to also protect your garden wire enclosure. Fitted with a rubber insert to prevent damage to the post.

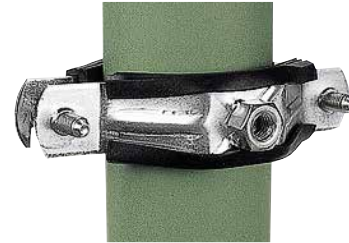

008780 Mounting bracket Premium 40/60mm M6/M8 5

Offset bolt-on insulator 20cm/M6



For electrifying non-electric fences quickly and effectively. Distance 20cm. With insulator suitable for wire and rope up to 9mm. To be used with steel posts. (External thread length 110mm M6 incl. 2xnut).



007516 Offset bolt-on insulator 20cm/M6 10

Live Tip Offset bolt-on insulator



The bolt in live tip insulator is the perfect solution for all heavy duty need. The live tip ensures that the insulator will also provide a shock to any curious critter that dares touch it. being able to bolt straight through any existing posts or pannels regardless of material means you can electrify an existing fence. an excellent solution for all heavy duty fencing requirements.



752334 Live Tip Offset bolt-on insulator 26cm/M6 20

Live Tip offset insulator wood 26cm



With an electrified tip and zero leakage through the post, the live tip offsets are an effective, new option for protecting existing fences. 10 year product warranty.



006190 Live Tip offset insulator 26cm 20

006183 Live Tip offset insulator 16cm 20

Live Tip offset insulator steel post 16cm



With an electrified tip and zero leakage through the post, the live tip offsets are an effective, new option for protecting existing fences. 10 year product warranty.



006145 Live Tip offset insulator steel post 16cm 20

Offset Pigtail insulator wood 17,5cm



For electrifying specific existing non-live fences quickly. Available in 2 lengths: 17.5cm or 40cm. Very suitable for rope and tape. Pre-drill hole and staple the offset to the wooden post.



010981	Offset Pigtail insulator 17,5cm white	10
720234	Offset Pigtail insulator 17,5cm terra	10

Offset Pigtail insulator wood 40cm



For electrifying specific existing non-live fences quickly. Available in 2 lengths: 17.5cm or 40cm. Very suitable for rope and tape. Pre-drill hole and staple the offset to the wooden post.



010998	Offset Pigtail insulator 40cm white	10
720135	Offset Pigtail insulator 40cm terra	10

Top mount double end Ring Top offset 80cm



By using this insulator, animals in adjacent pastures cannot come into contact with each other, which is ideal for keeping animals of a different gender apart. The insulator has also been designed to prevent injury if an animal comes into contact with it.



751924	Top mount double end Ring Top offset 80cm terra	5
--------	---	---

Offset Chainlink Insulator cainlink 30cm



For protecting and electrifying chain link netting. The completely galvanized clips are easy to fit to any type of netting. Pin lock insulator makes fixing the wire easy. 32cm long.



010912	Offset Chainlink Insulator 30cm black	25
--------	---------------------------------------	----

Offset Pinlock Insulator wire 30cm



For electrifying existing or run down fences. Easy to fix. 30cm long. Large spark guard. Pin lock for easy installation and removal of wires.

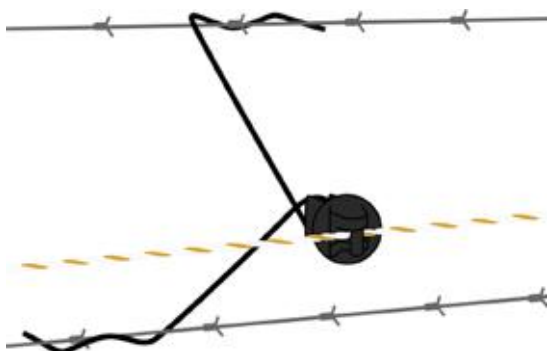

659046	Offset Pinlock Insulator 30cm black	25
--------	-------------------------------------	----

Screw-on rod insulator



For adding extra wire to round portable posts. Ideal for steel pigtail posts.



010943	Screw-on rod Insulator white for post 6/14mm (10)	10
011230	Screw-on rod Insulator green for post 8,5/13mm (250)	250
010936	Screw-on rod Insulator green for post 8,5/13mm (20)	20
656083	Screw-on rod insulator black for post 4/10mm (250)	250
010950	Screw-on rod insulator black for post 4/10mm (20)	20

Connectors are crucial in electric fencing. They are relatively small parts, but essential to proper current conductivity. Knotting wire together produces a loss of power, rendering the fencing ineffective. Fitting a good connector represents a minor investment, but you do have perfect fencing!

Joint clamp

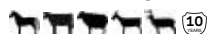

Essential for ensuring there is no loss of conductivity at connections. Effective animal control is dependant on optimum conductivity around the power fence. Heavily galvanized for durability and long life. Suitable for all size wires. Ensures effective electrical joints in the system. Bobbin clamp also suited for rope.



603568 Joint clamp bobbin with hex nut 100

010851 Joint clamp bobbin with hex nut 10

Joint clamp angle



Essential for ensuring there is no loss of conductivity at connections. Effective animal control is dependant on optimum conductivity around the power fence. Heavily galvanized for durability and long life. Suitable for all size wires and rope. Ensures effective electrical joints in the system.



060498 Joint clamp angle with hex nut 100

Joint clamp angle with wingnut



Essential for ensuring there is no loss of conductivity at connections. Effective animal control is dependant on optimum conductivity around the power fence. Heavily galvanized for durability and long life. Suitable for all size wires and rope. Ensures effective electrical joints in the system.



603964 Joint clamp angle with wingnut 100

010868 Joint clamp angle with wingnut 10

Tension spring 2,5mm/2,65mm



The tension spring neutralises the tension difference in the wire which is caused by fluctuations in temperature. It keeps the wire evenly tensioned during summer and winter, which means you can double (up to 15m) the distance between the posts. Suitable for 2.5mm and 2.65mm HT wire and EquiFence. Maximum tension strength 200kg. Stainless steel, length spring 345mm, Productwarranty 10 Year.



036257 Tension spring for 2,5mm/2,65mm HT/EQ wire 1

Tension spring 1,6mm/1,8mm



The tension spring neutralises the tension difference in the wire which is caused by fluctuations in temperature. It keeps the wire evenly tensioned during summer and winter, which means you can double (up to 15m) the distance between the posts. Suitable for 1.6mm and 1.8mm wire. Maximum tension strength 85kg. Stainless steel, length spring 155mm, Productwarranty 10 Year.



004133 Tension spring for 1,6mm/1,8mm wire 1

Wire tensioner



Use of this tensioner means that the wire does not have to be cut to strain it. Consequently, the power in the wire will be uninterrupted. Strong, lightweight, rust resistant construction. Can be used to join wires. Also suitable for rope. Does not rust. Product warranty: 10 years.



021475 Wire tensioner 25

010882 Wire tensioner 3

Insulated End Strainer



The wire tensioner has a streamlined design with super-strong polycarbonate to prevent rust. A wire clip has been integrated into the design to make it easy to fit an earth cable or connectors.



743134 Insulated End Strainer 20

618005 Insulated End Strainer fastening cable 2

Clip lock strainer



Clip lock strainers can be placed in the fence line during or after building your fence. For easy straining and re-straining your wires.



056095 Clip lock strainer 2

Handle for tensioner

Handle specially made for end-strain kit and clip lock strainer, very easy to use.



695303 Handle for tensioner 1

Vidoflex connector

This stainless steel clamp provides a good conductive connection between polywire. Easy to use.



060764 Vidoflex connector 4

Rope connector

This stainless steel clamp provides a good conductive connection between Rope or Vidoflex.



071159 Rope connector 25
019342 Rope connector 4

Rope connector with wingnut

This stainless steel clamp provides a good conductive connection between Rope/cord or Vidoflex.



075928 Rope connector with wingnut 4

Tape joiner

Innovative Gallagher design. For connecting and tensioning from 20mm up to 40mm tape. Easy to install using the rucksack clasp principle. Now it is easy to connect tension and release tape.



028962 Tape joiner 20/40mm 5
028979 Tape joiner 12,5/20mm 5

Tape joiner

To be used in combination with part no. 016702 or for joining and/or connect 20/40mm tape. Gives excellent mechanical and electrical connection. Made from non-rusting stainless steel.



010745 Tape joiner 20/40mm 5

Tape connector

Double connector for connecting two rows of tape. Length cable: 60cm.



055333 Tape connector tape/tape 60cm 1

Tape connector

Single connector for perfect connection from the energizer to the tape fence line. Length cable: 130cm.



055340 Tape connector tape/energizer 130cm 1

Gallagher has several options for making a gate. Are you familiar with the Gallagher multi-wire gate set? They are ideal! It allows you to open and close the gate with one hand. We also have a tough electric gate for permanent fencing.



Electrified steel gate



Adjustable, maintenance free gate, fully electrified. Suitable for all permanent fences incl. tape. Will fit gates from 2.5m to 4.5m. Height: 1.0m.



001064	Electrified steel gate 2,5 up to 4,5m	🔌 1
--------	---------------------------------------	-----

Mobile Cattle grid



This cattle grid is ideal to move. Because it is possible to connect an energizer to the grid, cyclists and pedestrians (and car traffic) can, for example, pass over it, but the animals remain in the fenced-in area.

Ask your dealer for the ordering conditions. Price on request.

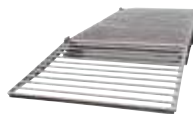

085576	Mobile Cattle grid 3,0 x 4,0m (LxW)	🔌 1
086535	Mobile Cattle grid 4,0 x 3,0m (LxW)	🔌 1
086542	Mobile Cattle grid 3,0 x 2,4m (LxW)	🔌 1
075935	Mobile Cattle grid 2,4 x 1,3m (LxW)	🔌 1

Drive thru Electro gate



A complete gate which can be erected anywhere where you have to drive frequently through a gate. Vehicles can push the gate open and the spring loaded gate closes automatically.



054923	Drive thru Electro gate 5,0m	🔌 1
004164	Drive thru Electro gate 3,7m	🔌 1

Multi strand gate kit



The most complete and easy to use all-in-one multi strand electric gate on the market. Provides a low cost gate solution for practically any width gateway. Comes with 40mm tape.

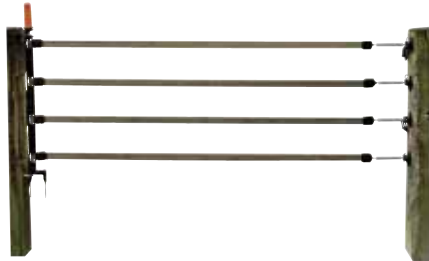

- | | | |
|---------------|--|-----|
| 718842 | Multi strand gate kit 4x40mm tape terra 6m | ☞ 1 |
| 718040 | Multi strand gate kit 4x12,5mm tape white 6m | ☞ 1 |



Retractable auto reel



Gate system with retractable reel, it automatically rolls and unrolls a walk way up to 15 m. Simple to install and easy to handle. Comes complete with gate handle and multi directional mounting bracket. Does not have a brake system. Available in white and terra.



- | | | |
|---------------|---------------------------------|-----|
| 010844 | Retractable auto reel white 15m | ☞ 1 |
| 054954 | Retractable auto reel terra 15m | ☞ 1 |

Retractable auto reel Cord



Gate system with retractable reel, it automatically rolls and unrolls a walk way up to 18 m. Simple to install and easy to handle. Comes complete with gate handle and multi directional mounting bracket. Does not have a brake system. Available in terra.



- | | | |
|---------------|--------------------------------------|-----|
| 083084 | Retractable auto reel cord terra 18m | ☞ 1 |
|---------------|--------------------------------------|-----|

Elastic rope gate set



Complete gate set (conductive cord, white), to quickly and easily create a passage in a (cord) fence. Easy to open and close by pick up the gate handle in or out of the included gate handle anchor. Suitable for gate passages starting from 3 up to 6 meters wide.

- | | | |
|---------------|----------------------------------|-----|
| 016412 | Elastic rope gate set white 3/6m | ☞ 1 |
| 072354 | Elastic rope gate set terra 3/6m | ☞ 1 |



- | | | |
|---------------|-------------------------------------|-----|
| 640556 | Elastic rope gate set white 6,5/11m | ☞ 1 |
| 891064 | Elastic rope white 50m | ☞ 1 |
| 891163 | Elastic rope terra 50m | ☞ 1 |

Spring gate set



Adaptable, gate closure. Complete set, maximum width 5 m. Not recommended for use with horses.



009084 Spring gate set 5m 1

016405 Spring gate set white 5m 1

Batt-Latch Gate Release Timer



Automatic gate opener. This system is ideal for opening a gate at a pre-set time. Extremely suitable for dairy farming and strip grazing. The system works on a battery with support from solar panels, ensuring the battery lasts longer.



077441 Batt-Latch Gate Release Timer 1

Soft touch gate handle Rope/wire



New design gatehandle, Unique rubber soft touch grip. Introduction buy 4 pay 3.



055722 Soft touch gate handle orange for rope/wire (Stainless steel) 4

697000 Soft touch gate handle orange for rope/wire (Stainless steel) 1

058198 Soft touch gate handle terra for rope/wire (Stainless steel) 4

057979 Soft touch gate handle terra for rope/wire (Stainless steel) 1

Gate handle



Heavy duty, durable gate handles in black and orange. Good visibility and large protective shields. 007585 has a compression hook for easy use. 010769 for attaching tape to a gate handle.



010776 Gate handle orange 1

010783 Gate handle black 1

Compression gate handle



Gate handle with compression hook for easy use.

072408 Compression gate handle N-hook black 10

007585 Compression gate handle N-hook black 1

PROMOTION



Soft touch gate handle Tape



New design gatehandle, suited specially for tape. Unique rubber soft touch grip. Introduction buy 4 pay 3.



055715	Soft touch gate handle orange for tape (Stainless steel)	4
696003	Soft touch gate handle orange for tape (Stainless steel)	1
058204	Soft touch gate handle terra for tape (Stainless steel)	4
057986	Soft touch gate handle terra for tape (Stainless steel)	1

Dual Purpose Portable handle



The new Dual Purpose Handle provides the flexibility to liven the fence from either the reel or handle end.



738321 Dual Purpose Portable handle 6

Gate break joiner



Tape clamp for fixing 40mm tape to a gate handle. Can be used with any gate handle.



010769 Gate break joiner 40mm tape 4

Gate handle anchor Premium Screw-in



Innovative Gallagher design. For attaching a gate handle. Stronger than all other gate handle anchors thanks to the new technique. Made of high-quality materials. Includes connector option for 1,6mm earth cable.



028986 Gate handle anchor 2-way screw-in black 5

Gate handle anchor Premium Bolt-on



Innovative Gallagher design. Anchor to attach a gate handle to steel posts. Stronger than all other gate handle anchors thanks to the new technique. Made of high quality materials.



060658 Gate handle anchor 2-way bolt-on black 5

Gate handle anchor Premium Pro Screw-in



For connecting a gate handle, with galvanized joining plate. We recommend the use of wire clamp (part no. 010851) to guarantee an optimum connection.



010905 Gate handle anchor 2-way screw-in black 4

Gate handle anchor Economy Screw-in



For connecting a gate handle.



010738 Gate handle anchor 2-way screw-in black 4

Gate handle anchor Premium 3-way



Gate anchor with 3 anchor points for Gallagher gate handles, ideal in multi-paddock situations. Power connects to bolt from below the plate. Comes with the 3mm galvanized plate.



021451 Gate handle anchor 3-way screw-on black 4

For more information and prices go to our website

www.gallagher.eu



If you are going to put up electric fencing you simply need the right tools. Whether you need to tension High Tensile fencing, cut wire, or screw down insulators, the job is simple when you use Gallagher tools.



Gallagher pliers



Gallagher pliers: These pliers are suitable for all types of fencing wire. High quality and durable. Minimum wire damage. Cuts high tensile wire.



005225 Gallagher pliers 

Farmer pliers



Farmer pliers: indispensable fence pliers for cutting wire or removing staples. Can also be used as a hammer.



004140 Farmer pliers 

Wire twister



With this wire twister, you can twist the wire clips around a wire without a problem. Ideal for use with Insultimber/Ecopost fences.



005232 Wire twister 

Gallagher Screws

Self drilling torx screws 4,5x40 with cylinder head. The special red wax layer makes pre-drilling unnecessary. T25 Screw bit included.



050000 Gallagher Screws 4,5x40 T25 

Drill chuck Pro



Support to easy mount almost the entire range of Gallagher ring and screw insulators with your battery drill. (Not suitable for 057801, 057818 and 009350)



077397 Drill chuck Pro 

086429 Drill chuck Metal 

Wire dispenser



Ideal for running out or winding up all types of wire. Fully galvanized for long life. Easy to use.



011018 Wire dispenser for fencing wire 

Post holer

Low cost and easy to use tool for installing soft wood posts. Using the postholer makes fencing easy and prevents the post from getting damaged when using a sledge hammer. Two diameters available.

- **704668** Post holer 100mm 1
- **704644** Post holer 75mm 1



Sledge hammer

Indispensable for driving Eco posts to correct depths without damaging posts. Prevents posts from standing out of line.

- **017614** Sledge hammer 1



Rammer

Indispensable for driving Insultimber posts to correct depths without damaging posts. Prevents posts from standing out of line.

- **035311** Rammer Insultimber post 1
- **017652** Rammer Eco post 1



Rammer

Special rammer for convenient hammering in of a Gallagher Line post.

- **525013** Line Post Rammer 1



Line Post Accessories

Sleeve for Line Post rammer 1350mm and 1500mm.

- **530031** Line Post Rammer sleeve 1



Line Post Accessories

Line Post Auger to easily place Gallagher Line Posts in hard ground. Handy tool designed specifically for the Gallagher Line Post.

- **540016** Line Post Pilot 1



Line Post Accessories

Line Post Post lifter to easily pull out the Gallagher Line Post. Handy tool designed specifically for the Gallagher Line Post. To be used together with the universal post lifter (art. no 527000)

- **527017** Line Post Lifter Adapter 1



Universal post Lifter

Post Lifter, suitable for the Line Post lifter adapter To easily pull out the Gallagher Line Post.

- **527000** Universal post Lifter 1



Wire tensioner

Tool for installing ratchet tensioners in fencing.

- **029044** Wire tensioner Basic 1



Wire tensioner

An essential tool for use with Permanent Wire Tightener. Fast and easy to use, even in confined areas. One way bearing allows ratchet action of the handle.

- **006451** Wire tensioner Pro 1



Step-by-step installation



When requiring effective and permanent fencing, you choose hardware in materials that will last for many years. It is therefore also essential that your permanent fencing is installed properly. We would therefore like to give a general guide on how best to construct a permanent fence.

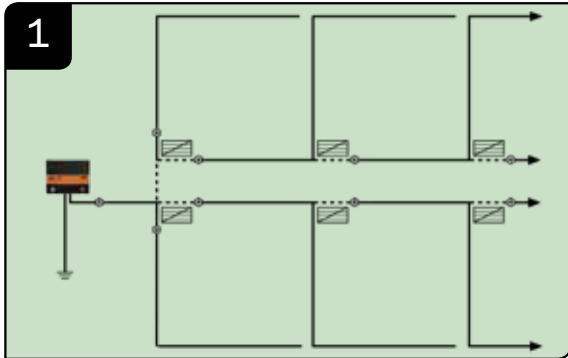

1 Draw a ground plan



2 Determine the required wire height
(see page 84)

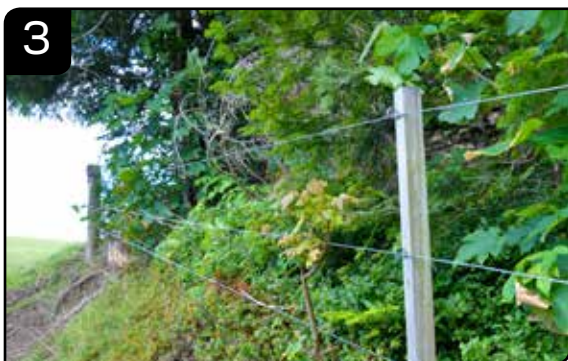

3 First fit the corner posts



4 Fit the intermediate posts



5 Fit and tension the fencing



6 Install the energizer and earthing

For more detailed information, please check www.gallagher.eu.



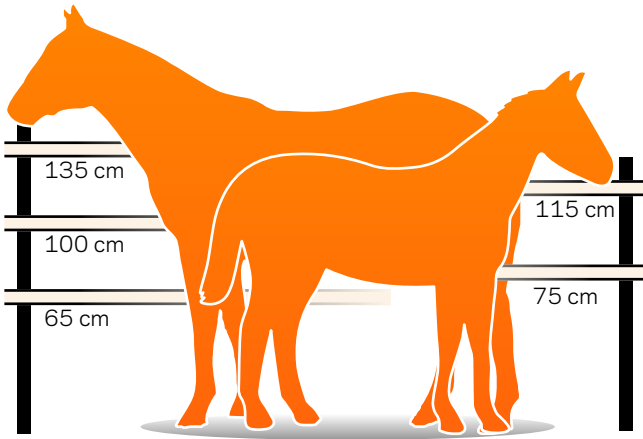

Horses

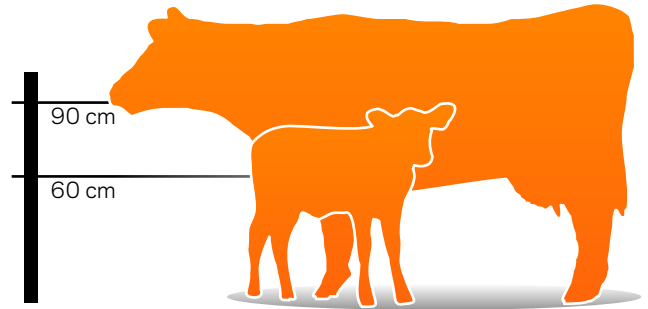

Cows with calves

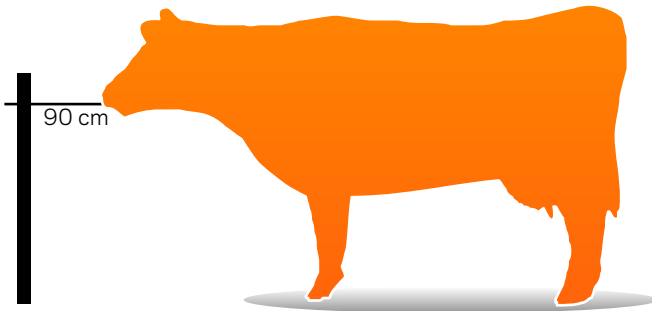

Cows without calves

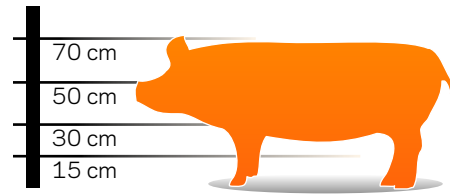

Pigs

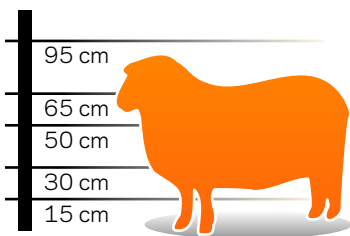

Sheep

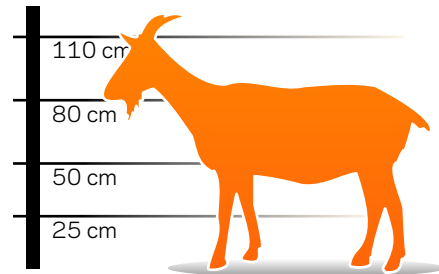

Goats

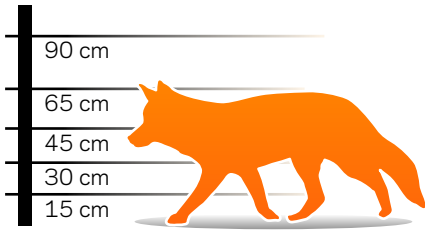

Foxes

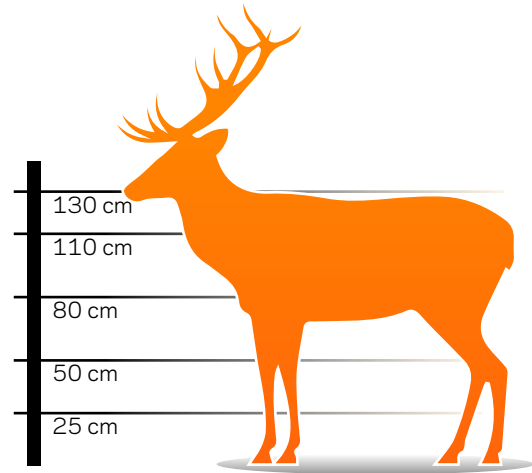

Deer

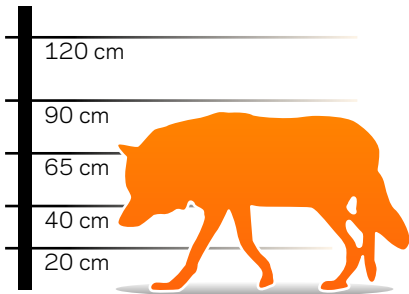

Wolves



Wild boar

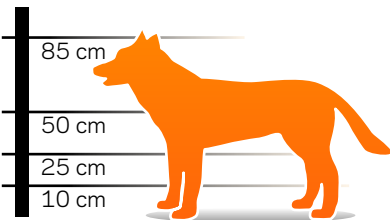

Large dogs



Small dogs

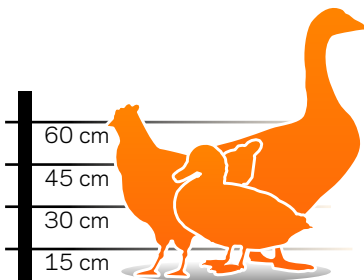

Poultry

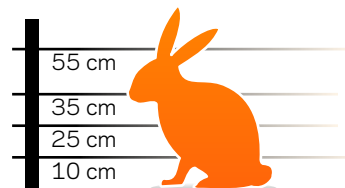

Rabbits

As an animal lover, you want to be certain that your animals stay safely in their field, and you do not want breakouts. It is therefore essential to check your fencing in order to be certain that it's working optimally. Spring is the perfect time to check the fencing, for a fresh new start of the grazing season.

DO THE GALLAGHER CHECK!



Handy testers for the Gallagher Check



p. 41

Neon tester



p. 41

Fault finder for electric fencing



p. 41

Digital voltmeter

All the steps are of course explained in detail in the Gallagher Check video. Go to www.gallagher.eu/check for more information or scan the QR code.



STEP 1 CHECK YOUR ENERGIZER

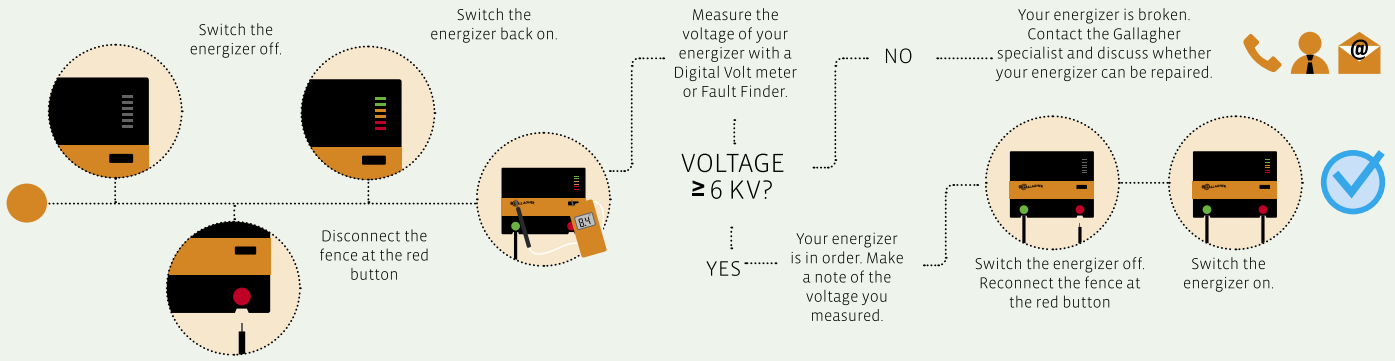

STEP 2 CHECK THE VOLTAGE ON YOUR FENCING

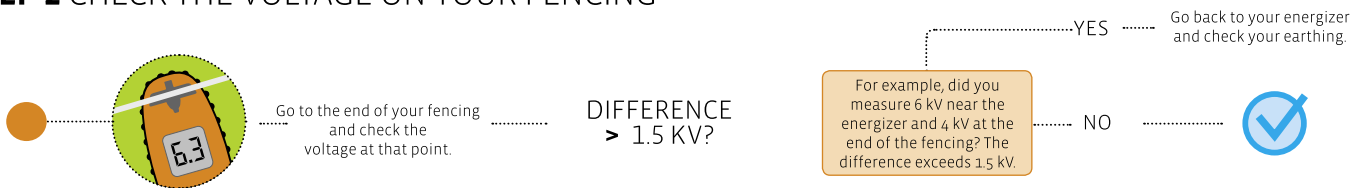

STEP 3 CHECK YOUR FENCING

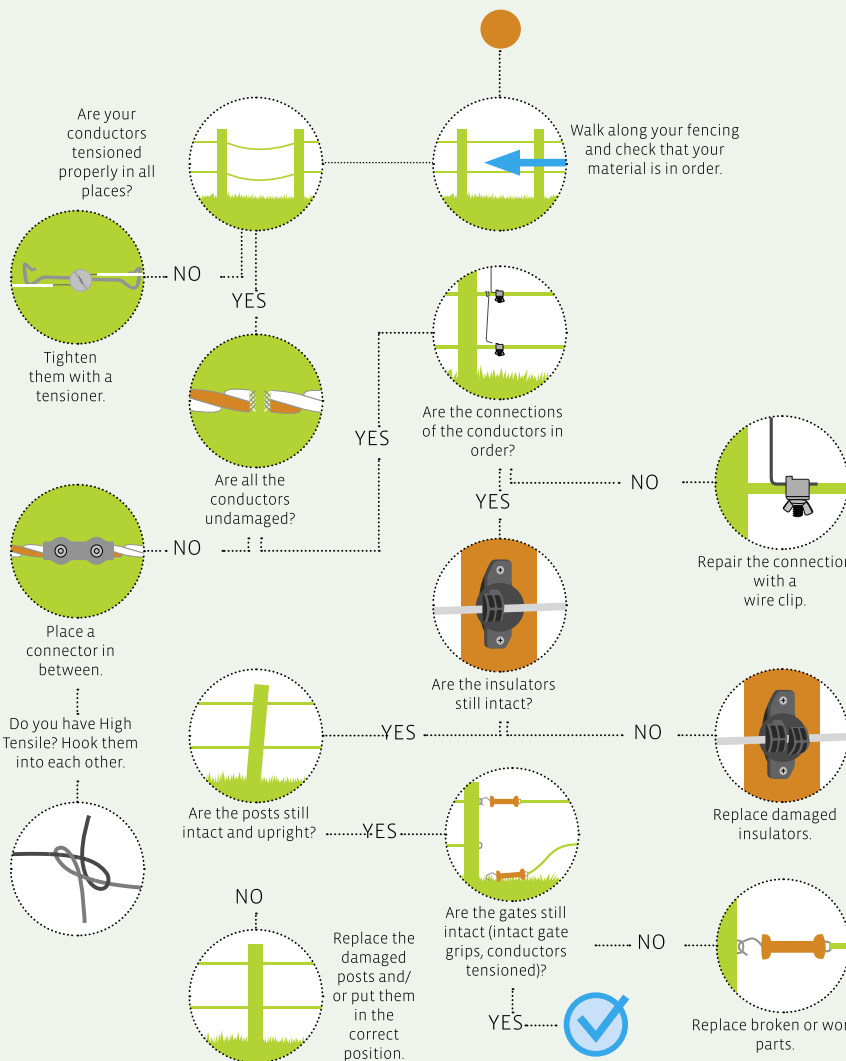

STEP 4 CHECK YOUR EARTHING

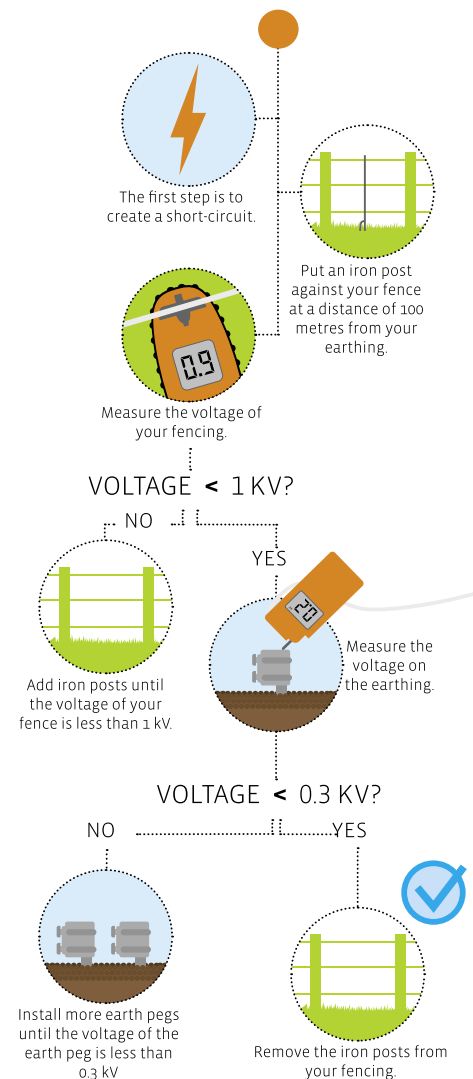

With more than 80 years' experience in the agricultural industry and a reputation for trendsetting innovations, Gallagher is ahead of the field when it comes to Weighing and EID solutions – offering a complete range of equipment for weighing animals, gathering data, and EID systems.

WEIGHING & DATA RECORDERS



Weigh scale

The most intuitive EID ready scale on the market, manage weight gain to maximise profit. The TW-1 is ideally suited to those customers who are solely focussed on weight gain. The alpha-numeric keypad allows for the entry of tag information or animal notes, with the familiar tap-text entry functionality of the HR5.

026015 TW-1 Weigh Scale 1



Weigh scale

The perfect scales to start weighing your animals. Monitor animal weights to gain an insight into performance. With easy installation, user-friendly design and connectivity to the Gallagher Animal Performance App, the W-0 is the ideal solution for livestock farmers who want to start monitoring the weight of their animals.

025001 Weigh scale W0 1

NEW! WIRELESS LOADBARS

Wireless Loadbar set

With these new wireless loadbars, you can prevent the most common problem with traditional loadbars: the wires. Convert your phone into scales by connecting with the Animal Performance+ App and the Bluetooth function. This wireless loadbar can be positioned under a platform or a weighing cage. Suitable for livestock and exotic animal species.

060309 Wireless Loadbar set 2500kg - 600mm 1
 061306 Wireless Loadbar set 2500kg - 1000mm 1
 063300 Heavy Duty Wireless Loadbar set 5000kg - 1000mm 1



See the special catalogue for the complete range

Go to www.gallagher.eu for more information or scan the QR code.



EID TAG READERS

An EID tag reader is a critical part of an EID system. The reader captures the unique tag number of individual animals as they are weighed, treated, or identified in a yard or race.

SmartReader

Portable Hand Held EID Tag Reader and data collection. High performance readers provide a super-fast read of both HDX and FDX-B tags, and with an ergonomic and hard wearing design they are the perfect tool for portable EID data collection. With its large colour screen and alpha numeric keypad, the HR5 is the most powerful portable data collection and editing platform available providing flexibility right there in the yard. Farmers can record, edit and customise data against EID records immediately without needing to set it up in the office first.

033037 SmartReader HR5



SmartReader

Portable Hand Held EID Tag Reader and data collection. High performance readers provide a super-fast read of both HDX and FDX-B tags, and with an ergonomic and hard wearing design they are the perfect tool for portable EID data collection. Easy recording of pre-defined animal data against EID tag numbers.

068944 SmartReader HR4



MANAGE THE DATA IN THE CLOUD WITH THE GALLAGHER ANIMAL PERFORMANCE MANAGEMENT APP

The new Gallagher Animal Performance management app makes it possible to have the data on the herd at anytime and anywhere. You can make FREE use of the Gallagher Animal Performance management environment! It is possible to log into your own account on the scales, smartphone or a computer. The devices communicate with each other through Wi-Fi to make sure every device has the correct data. Its design and user-friendliness make it accessible to any user.

Birth Alarm is a birth-alert system and monitors the horse's health



BIRTH ALARM FOR MONITORING HEALTH

Always know what is going on with your horse. Now you can with Birth Alarm's solutions. A number of Birth Alarm's products have a 'monitoring setting'. Generally, a horse will not lie down for a long period of time. If the owner suspects that the horse has a health issue, a Birth Alarm can be attached to the halter or to the horse's antiroll girth. When the horse lies down, the owner receives an alert, and he or she can take action immediately.

Birth Alarm Premium Plus

Birth Alarm Premium Plus is the system for ultimate control and comprehensive options. With the pre-programmed SIM card with 5 years of credit, individual purchase is not required. With the free Telegram app on your smartphone, you are always connected with all the alarms and status messages of your Birth Alarm. Telegram provides the option of creating a group so that several people receive alerts from your system at the same time.

086467 Birth Alarm Premium Plus 1



NEW
WITH FREE
TELEGRAM
APP



See the special catalogue for the complete range

Go to www.gallagher.eu for more information or scan the QR code.



Birth Alarm Premium

The system for ultimate control and comprehensive options. Contains a unique sleep mode especially designed for mares that sleep fully flat. Option to connect to 4 mobile phones. Including the option to retrieve status messages. The transmitter can be fitted in the anti-roll girth or on the halter, depending on the preference of the mare.



084548 Birth Alarm Premium 1

Birth Alarm Lite 2.0

The entry-level model of the Birth Alarm range. Easy to install, a system in which the transmitter sends a timely alert to a maximum of two connected mobile phones. The transmitter can be fitted in the anti-roll girth or on the halter, depending on the preference of the mare. Now with sleep mode!



084555 Birth Alarm Lite 2.0 1

Foaling alarm

The Birth Alarm Classic has proven its worth in recent years as a highly reliable birth alarm system for mares. The system consists of a transmitter, a fixed receiver and an assembly kit. This system can be used for mares that sleep fully flat. It can also be used to monitor the health of the horse (colic mode).



510 Birth Alarm Classic 1

511 Birth Alarm Classic, incl. Anti roll girth 1

Foaling alarm

The Birth Alarm Mobile works with a transmitter and the mobile phone as a receiver. Two different phones can serve as receivers. The transmitter must be fitted in an anti-roll girth. This transmitter contains a unique sleep mode especially designed for mares that sleep fully flat.



025480 Birth Alarm Mobile 1

027934 Birth Alarm Mobile Complete, incl. anti-roll girth 1

BIRTH ALARM CAMERA SYSTEMS



You may want to see what is going on in the stables or in the paddock at any time of the day. Therefore, Birth Alarm produced two camera systems that provide you with even more monitoring and overview. In combination with the other Birth Alarm products, these cameras provide optimum monitoring.

000655 PoE camera 1

054628 Wifi camera 1

Birth Alarm Mobile Complete

The Birth Alarm Mobile, now available in combination with the Foscam WiFi camera, anti-roll girth and 1,25m girth! A very attractive combination to monitor the mare as closely as possible during the birth of the foal. The Birth Alarm Mobile triggers an alarm, after which the combination with the camera provides the ideal solution.

084654 Birth Alarm Mobile Complete, incl. WiFi Camera 1

PROMOTION

WHILST STOCKS LAST!



Eradicating rats and mice without poison Nobody wants to have rats and mice in their house, shed, or garden. They gorge on feed and bite through wiring. Their urine stinks and stains and we have not even mentioned the diseases they carry. If you remember that two mice can produce a colony of 700 in just a year, the need to eradicate mice is clear. Using poison is no longer an option for agricultural companies, and from 2023 it will also be prohibited in households. With Goodnature, Gallagher provides an effective solution for rats and mice.



A24 RAT AND MOUSE TRAP. AUTOMATIC, POISON-FREE AND HUMANE

Goodnature started in New Zealand with protecting endangered animals in the wild all over the world. That includes eradicating rodents, such as mice and rats, in the most animal-friendly manner without using dangerous poisons. That was the principle for developing humane traps for unwanted animals.

How does the automatic rat and mouse trap work?

1 Sniff

The bait attracts rats and mice.

2 Strike

The animal touches the trigger and activates the trap. The rat or mouse dies instantly.

3 Automatic reset

The trap resets itself and is immediately ready for use.

4 Sniff

The bait stays active and attracts new animals.

5 Disposal

Other animals, such as birds of prey and cats, take the dead animals away. As it does not involve poison, it does not end up in subsequent chains of the ecological system. A cat or bird of prey will not become ill by eating the dead animal.

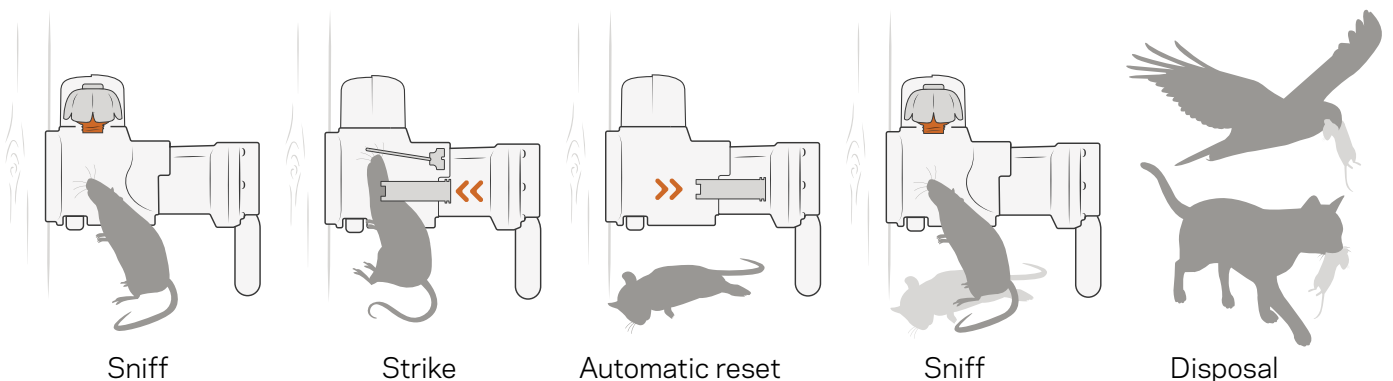

Automatic

The A24 rat and mouse trap works up to 24 times with one CO2 canister, and is supplied with a bait cartridge that automatically dispenses the bait for up to 6 months. The trap is supplied with a digital strike counter that shows how often the trap has been activated.

Safe

Goodnature products are humane, effective and safe to use. The traps have been designed to attract rodents and nothing else.

Humane

The traps kill the animal immediately, without suffering. The traps have been tested independently, and comply with the strictest international standards.

Easy to use

They are easy to install and set up, both indoors and outdoors. The trap is supplied with a mount that is easy to attach to a tree trunk or a wooden post. If you prefer to put the trap on the ground, you can order the trap stand separately.

Constant control

As the trap can be triggered 24 times per canister and resets itself, there is no need to keep checking it. Setting it once is sufficient.

Hard wearing









The traps are extremely durable. They were designed for indoor use, but were also tested in rugged outdoor conditions



758641	A24 Automatic rat- and mousetrap with trap counter	📦 1
483025	Rodent Detector Kit- 25 Pack	📦 1
750836	A24 tree Mount Kit	📦 1
750850	A24 1 Year Replenishment Pack	📦 1
725643	A24 Stand - Retail	📦 1
758702	Rat Auto Lure Pump	📦 1
081936	A24 Lure Basket	📦 1
483018	A24 Blocker	📦 1
745603	A24 CO2 Canister - 1 Pack	📦 1
083312	Rat Lure- 200gr Pouch (1)	📦 1
483117	Goodnature rat lure pouch nut butter 200g (10-pack)	📦 1
745696	Digital Strike Counter Goodnature A24	📦 1



Specifications of 230V energizers

	M35	M50	M120	M160	M350	M550	M650	M950	M1400
									
	383361	038332	033333	384306	323305	323312	323329	324302	324319
Output Voltage (V)	5300	5900	6800	7600	8700	9200	9200	7700	7700
Output with 500 Ohm (V)	3000	3500	3800	4600	6300	7000	7100	7700	7700
Voltage with 100 Ohm (V)	900	1100	1300	1600	3200	3500	3600	3800	4300
Stored Energy (J)	0,4	0,6	1,4	1,5	3,5	5,5	6,5	9	12
Output Energy (J)	0,23	0,27	0,47	0,6	2,7	3,9	4,5	6,1	7,7
Single Wire Fence distance - Ideal conditions (km)	4	10	30	39	85	110	115	125	145
Multi (2) Wire Fence distance - Ideal conditions (km)	2	4	8	9	28	35	40	42	55
Multi (2) Wire Fence distance - Light conditions (km)	1	2	3	3,5	12	25	28	31	34
Multi (3) Wire Fence distance - Recommended (km)	0,5	1	2	2,5	7	9	10	11	14
Grid area (Hec/Acre)	1/3	2/5	4/10	6/14	14//35	22/55	26/65	38/95	56/140
Avg. power cons.(W)	0,6	0,6	0,9	1,6	6	7	8	11	14
Horse, Cattle	-	-	▪	▪	▪	▪	▪	▪	▪
Sheep, Goat	-	-	-	-	▪	▪	▪	▪	▪
Pig	-	-	-	▪	▪	▪	▪	▪	▪
Game	-	-	-	-	▪	▪	▪	▪	▪
Domestic animals, Pond and garden	▪	▪	▪	▪	-	-	-	-	-
Power led on/off	▪	▪	▪	▪	▪	▪	▪	▪	▪
Alarm-indicator-LED Earth voltage	-	-	-	-	-	-	-	-	▪
LED bar graph	-	-	-	-	-	-	-	-	-
12V Battery backup	o	o	o	o	o	o	o	o	o
Adaptive Control	-	-	-	-	-	-	-	▪	▪
Delay with load (Timedelay)	-	-	-	-	-	-	-	▪	▪
Security with short-circuit	-	-	-	-	-	-	-	▪	▪
Built-in lightning diverter	▪	▪	▪	▪	▪	▪	▪	▪	▪
Recommended number of earth stakes	1x0,5m	1x1m	2x1m	2x1m	3x2m	3x2m	3x2m	4x2m	4x2m
Advised Bentonite Super Earth Kit (number of buckets)	-	-	-	-	1	1	1	2	2
Compliance	EN60335-2-76A11	EN60335-2-76-A11	EN60335-2-76-A11	EN60335-2-76-A11	EN60335-2-76-A11	EN60335-2-76-A11	EN60335-2-76-A11	EN60335-2-76-A12	EN60335-2-76-A12
IPX classification	IPX4	IPX4	IPX4	IPX4	IPX4	IPX4	IPX4	IPX4	IPX4
Warranty	3 Years	3 Years	3 Years	3 Years	3 Years	3 Years	3 Years	3 Years	3 Years
Dimensions (lxbxh mm)	145x75x170	145x75x170	145x75x170	145x75x170	180x90x220	180x90x220	180x90x220	268x95x212	268x95x212
Weight (Kg)	0,80	0,83	0,87	1,7	1,5	1,5	1,5	2,8	2,8

▪ Standard / suitable for

o Optional

- Not compatible / not suitable for

*Use only during Grazing season.

**Automatic

M5000i

MBS1800i MBS2800i

Specifications of the i Series



	379326
Output Voltage (V)	9000
Output with 500 Ohm (V)	9000
Voltage with 100 Ohm (V)	8200
Stored Energy (J)	19
Output Energy (J)	15
Single Wire Fence distance - Ideal conditions (km)	300
Multi (2) Wire Fence distance - Ideal conditions (km)	100
Multi (2) Wire Fence distance - Light conditions (km)	60
Multi (3) Wire Fence distance - Recommended (km)	26
Grid area (Hec/Acre)	160/400
Power cons. min/max (W)	*11/18
Horse, Cattle	▪
Sheep, Goat	▪
Pig	▪
Game	▪
Power led on/off	▪
External Display	▪
Easy-to-read display Power (A)	▪
Easy-to-read display Output voltage (V)	▪
Easy-to-read display Earth voltage (V)	▪
Easy-to-read display Return voltage (V)	o
Alarm-indicator-LED Fence voltage	▪
LED bar chart	▪
Sound Alarm Fence-Earth	▪
Terminal Reference Earth	▪
Connection option external alarm-control unit	o
12V Battery backup	o
Adaptive Control	▪
Full-Half Power Option	▪
Delay with load (Timedelay)	▪
Security with short-circuit	▪
SMS Capable	o
Remote control	o
Built-in lightning diverter	▪
Recommended number of earth stakes	8x2m
Advised Bentonite Super Earth Kit (number of buckets)	3
Compliance	EN60335-2-76-A12
IPX classification	IPX4
Warranty	3 Years
Dimensions (lxbxh mm)	430x140x310
Weight (Kg)	8,8

Specifications of the MultiPower i Series



	315317	315331
Output Voltage (V)	7000	7000
Output with 500 Ohm (V)	7000	6400
Voltage with 100 Ohm (V)	5200	5400
Stored Energy (J)	14	21
Output Energy (J)	10	14
Single Wire Fence distance - Ideal conditions (km)	195	240
Multi (2) Wire Fence distance - Ideal conditions (km)	65	80
Multi (2) Wire Fence distance - Light conditions (km)	40	50
Multi (3) Wire Fence distance - Recommended (km)	17	20
Grid area (Hec/Acre)	75/190	120/300
Max. current draw - 12V Battery (mA)	*850	*1200
Avg. power cons. 15V Powersupply (W)	*13	*17,7
Battery performance - normal modus (days/VAh)	^1,5 days / 12V105Ah	^1 dag / 12V105Ah
Horse, Cattle	▪	▪
Sheep, Goat	▪	▪
Pig	▪	▪
Game	▪	▪
Battery safemode	▪	▪
Battery LED (indicator)	▪	▪
Device indicator light On/Off	▪	▪
Built-in lightning protection	▪	▪
Remote control	o	o
Auto power conservation to prevent damage to battery	▪	▪
External display	▪	▪
Easy-to-read display power (A)	▪	▪
Easy-to-read display output voltage (V)	▪	▪
Easy-to-read display earth voltage (V)	▪	▪
Easy-to-read display return voltage (V)	o	o
Alarm indicator LED fence voltage	▪	▪
Half power mode	▪	▪
Normal - slow pulse mode	**	**
Sound alarm fence / earth	▪	▪
Terminal reference earth	▪	▪
Connection option external alarm-control unit	o	o
12V Battery backup option	o	o
Power depending on condition fence	▪	▪
Full / half power option	▪	▪
Time delay with load	▪	▪
Security with short-circuit	▪	▪
SMS capable	o	o
Powersupply included	▪	▪
Suitable powersupply (Part No./Part No.)	401324	401324
12V Battery Leadset MB/MBS Series included	582207	582207
Suitable for solar panel (minimal advised)	2x60W	2x60W
Recommended number of earth stakes	5x2m	6x2m
Advised Bentonite Super Earth Kit (number of buckets)	2	2
Compliance	EN60335-2-76-A12	EN60335-2-76-A12
IPX classification	IPX4	IPX4
Warranty	3 Years	3 Years
Dimensions (lxbxh mm)	345x95x205	345x95x205
Weight (Kg)	4,2	5,6

Specifications of the MultiPower MB Series & MultiPower MBS Series

MB150

MB300

MBS200

MBS400

MBS800



	388311	388328	389318	390307	390314
Maximum Output Voltage (V)	8500	9100	9000	9100	9200
On load voltage 500 Ohm (V)	5500	5900	5800	6400	6700
Load voltage 100 Ohm (V)	2200	2400	2300	2300	2700
Charge energy (J)	1,5	2,7	2	4	7,5
Maximum pulse energy (J)	1,2	2	1,5	3	4,9
Single wire - Ideal conditions (km)	50	75	65	85	100
Multi-wire (2) distance - Ideal conditions (km)	15	25	20	30	40
Multi-wire (2) distance - Light vegetation (km)	10	16	13	19	29
Multi-wire (3) distance - Recommended (km)	4	6	5	8	10
Grid area (Ha/Acre)	6/15	12/30	8/20	16/40	32/80
Average / Max. power consumption 12V Battery (mA)	195/276	217/276	176/310	195/900	331/1000
Average current consumption of 12 V battery (mA)	-	-	-	-	-
Average current consumption 15 V Adaptor (W)	2,9	3,3	2,64	3,9	6,7
Battery life - normal mode (days/VAh)	^15 days / 12V85Ah	^12 days / 12V85Ah	^12 days / 12V105Ah	^9 days / 12V105Ah	^5 days / 12V105Ah
Horse, Cattle	▪	▪	▪	▪	▪
Sheep, Goat	▪	-	▪	▪	▪
Pig	-	▪	-	-	▪
Game	▪	▪	▪	▪	▪
Pets, Garden and Pond	▪	-	▪	▪	▪
Battery save mode	▪	-	▪	-	-
Battery check light (indicator)	▪	▪	LED Bar	LED Bar	LED Bar
Battery check mode	-	-	▪	▪	▪
Smart battery management	-	-	▪	▪	▪
Battery low voltage warning	-	-	▪	▪	▪
Device on/off indicator	▪	▪	▪	▪	▪
Built-in lightning protection	▪	▪	▪	▪	▪
Remote control	-	-	-	-	-
Auto protection when battery discharged	▪	▪	▪	▪	▪
Alarm indicator LED fence voltage	-	-	▪	▪	▪
Solar panel and battery mode	-	-	▪	▪	▪
Battery only mode	-	-	▪	▪	▪
Mains power mode	-	-	▪	▪	▪
Battery only mode	-	-	▪	▪	▪
Night saver mode	-	-	-	-	-
Normal - slow pulse mode	-	-	-	-	-
Random pulse mode	-	-	-	-	-
Power dependent on fence condition	-	-	-	-	-
Time delay on load	-	-	-	-	-
Protection against grid short circuit	-	-	-	-	-
Adapter included	-	-	▪	▪	▪
Suitable adapter (Art.no./Art.no.)	401218 053865	401218 053865	401218 053865	401218 053865	401218 053865
12V Battery cable set MB/MBS included	582207	582207	582207	582207	582207
Grid cable set included	004938	004938	004938	004938	004938
Suitable for solar panel (minimum recommendation)	*20W	*30W	*20W solar kit part No. 495217	*40W solar kit Part No. 495415	*60W
Suitable for Gallagher Solar support box (073511)	▪	▪	▪	▪	▪
Suitable for Burglary resistant box (0199410)	▪	▪	▪	-	-
Recommended number of earth stakes	3x1m	4x1m	4x1m	4x1m	4x2m
European standard	EN60335 -2-76-A11	EN60335 -2-76-A11	EN60335 -2-76-A11	EN60335 -2-76-A11	EN60335 -2-76-A11
IPX classification	IPX4	IPX4	IPX4	IPX4	IPX4
Warranty	3 Years	3 Years	3 Years	3 Years	3 Years
Dimensions (lxbxh mm)	200x110x 220	200x110x 220	200x110x220	245x130x270	245x130x270
Weight (Kg)	1,3	1,4	1,9	2,6	2,9

Specifications of 12V energizers & 9V energizers

	B60	B100	B200	B300	B10	BA20	BA30	BA40	BA80
	388304	392004	393001	394008	003634	356310	356303	356327	356358
Maximum Output Voltage (V)	8500	10000	9000	10000	7900	9600	9600	9400	9400
On load voltage 500 Ohm (V)	3500	3500	4300	5800	1200	1700	2000	1800 / 1400	2200 / 2000
Load voltage 100 Ohm (V)	1100	1100	1400	1600	400	500	500	450 / 340	560 / 480
Charge energy (J)	0,6	0,8	1,5	2,6	0,1	0,17	0,25	0,4	0,8
Maximum pulse energy (J)	0,4	0,55	1,1	2	0,07	0,12	0,19	0,26	0,48
Single wire - Ideal conditions (km)	25	30	60	90	2	3	5	18	24
Multi-wire (2) distance - Ideal conditions (km)	8	10	20	30	1	2	4	6	10
Multi-wire (2) distance - Light vegetation (km)	2	5	7	10	-	1,5	3	3	5
Multi-wire (3) distance - Recommended (km)	1	3	5	8	0,5	0,5	0,75	1,5	3
Grid area (Ha/Acre)	3/7	4/10	10/25	15/40	0,5/1,3	0,8/2	1/2,5	2/5	4/10
Average current consumption 12V Battery (mA)	49	60	120	200	15	24	34	43	90
Average current consumption of energy-saving mode 12 V battery (mA)	-	35	40	71	^30 days	^90 days / 9V55Ah	^65 days / 9V55Ah	^160 days / 9V175Ah	^90 days / 9V210Ah
Battery duration - normal mode (days/VAh)	^35 days / 12V85Ah	^35 days / 12V85Ah	^22 days / 12V85Ah	^12 days / 12V85Ah	*/	*/	*/	*/	*/
Horse, Cattle	▪	▪	▪	▪	▪	▪	▪	▪	▪
Sheep, Goat	▪	▪	▪	▪	-	▪	▪	▪	▪
Pig	▪	▪	▪	▪	▪	▪	▪	▪	▪
Game	-	▪	▪	▪	-	-	▪	▪	▪
Pets, Garden and Pond	-	-	-	-	-	-	-	-	-
Battery warning light (indicator)	▪	▪	▪	▪	▪	▪	▪	▪	▪
Auto protection when battery is discharged	▪	▪	▪	▪	-	-	-	-	-
Battery save mode	-	▪	▪	▪	▪	▪	▪	▪	▪
Half power mode	-	▪	▪	▪	-	▪	▪	▪	▪
Daytime economy mode	-	▪	▪	▪	-	-	-	▪	▪
Night economy mode	-	▪	▪	▪	▪	@12V	@12V	@12V	@12V
Normal - slow pulse mode	-	▪	▪	▪	-	-	-	-	-
Suitable for solar panel (minimum recommendation)	GE recommends MB/ MBS series energizer	*10W	*20W	*30W	▪	-	-	-	-
Battery connection cable included	▪	▪	▪	▪	▪	▪	▪	▪	▪
Grid cable included	▪	▪	▪	▪	-	-	-	▪	▪
Adapter included	-	-	-	-	-	-	-	-	-
Suitable adapter (Art. no.)	-	053865	053865	053865	1x0,5m	1x0,5m	1x0,5	1x1m	1x1m
Recommended number of earth stakes	1x1m	2x1m	3x1m	4x1m	-	-	-	-	-
European standard	EN60335 -2-76-A11	EN60335 -2-76-A11	EN60335 -2-76-A11	EN60335 -2-76-A11	EN60335 -2-76-A11	EN60335 -2-76-A11	EN60335 -2-76-A11	EN60335 -2-76-A11	EN60335 -2-76-A11
IPX classification	IPX4	IPX4	IPX4	IPX4	IPX4	IPX4	IPX4	IPX4	IPX4
Warranty	3 Years	3 Years	3 Years	3 Years	3 Years	3 Years	3 Years	3 Years	3 Years
Dimensions (lxbxh mm)	200x110x220	320x210x380	320x210x380	320x210x380	80x80x175	280x160x295	280x160x295	280x160x295	280x160x295
Weight (Kg)	1,4	3,58	3,58	3,7	0,53	1,6	1,6	1,6	1,6

- Standard / suitable for
- o Optional
- Not compatible / not suitable for

* Use only during Grazing season.
** Automatic

Specifications of solar energizers



	S6	S12	S16	S20	S40LE	S40	S100	S200	S400
	349008	349015	341316	341323	345321	345307	346304	360300	361307
Output Voltage (V)	7500	9000	6900	6900	7500	7900	9600	9600	9600
Output with 500 Ohm (V)	1000	1500	2000	2100	2000	2300	3600	4900	6000
Voltage with 100 Ohm (V)	350	500	500	500	750	800	1000	1700	2400
Stored Energy (J)	0,08	0,12	0,16	0,2	0,36	0,4	1	2	4
Output Energy (J)	0,06	0,08	0,13	0,14	0,23	0,26	0,74	1,6	3,1
Single Wire Fence distance - Ideal conditions (km)	1	3,5	4,5	9	15	15	30	50	65
Multi (2) Wire Fence distance - Ideal conditions (km)	0,5	1,5	1,5	3	5	5	10	20	30
Multi (2) Wire Fence distance - Light conditions (km)	0,2	0,7	0,8	1,5	3	3	5	10	16
Multi (3) Wire Fence distance - Recommended (km)	0,1	0,4	0,5	1	1,5	1,5	3	5	7
Grid area (Hec/Acre)	0,1/0,25	0,75/1,5	0,8/2	1,2/3	2/5	2/5	4/10	8/20	16/40
Avg. current draw Battery (V/mA)	3,2V 39/29 day/night	3,2V 39/29 day/night	6/21	6/28	6/46	6/46	12/43	12/171	12/321
Days operational with no daylight	-	-	^20 days	^20 days	^20 days	^20 days	^20 days	^15 days	^10 days
Horse, Cattle	-	▪	▪	▪	▪	▪	▪	▪	▪
Sheep, Goat	-	▪	-	-	▪	▪	▪	▪	▪
Pig	-	▪	▪	▪	▪	▪	▪	▪	▪
Game	-	-	-	-	-	▪	▪	▪	▪
Domestic animals, Pond and garden	▪	▪	▪	▪	-	-	-	-	-
Device indicator light On/Off	▪	▪	-	▪	▪	▪	▪	▪	▪
Battery LED (indicator)	▪	▪	▪	▪	▪	▪	▪	▪	▪
Battery safemode	-	-	▪	▪	▪	▪	▪	▪	▪
Auto power conservation to prevent damage to battery	-	-	-	▪	▪	▪	▪	▪	▪
Half power mode / Wildlife mode	-	-	-	-	-/▪	-/▪	-/▪	-/▪	-/▪
Night savings option	-	-	▪	▪	▪	▪	▪	▪	▪
Normal - slow pulse mode	-	-	-	-	▪	▪	▪	▪	▪
Fence connection wire included	▪	▪	▪	▪	▪	▪	▪	▪	▪
Build-in solar panel	2,2W	2,2W	1,5W	1,5W	5W	4W	7W	20W	40W
Rechargeable Battery included	▪	▪	▪	▪	▪	▪	▪	▪(2x)	▪(2X)
Recommended Battery (minimal advised)	Lithium 3,2V-6Ah	Lithium 3,2V-6Ah	VRLA 6V-4Ah	VRLA 6V-4Ah	VRLA 6V-10Ah	VRLA 6V-10Ah	VRLA 12V-7.2Ah	*2x VRLA 12V-7.2Ah	*2x VRLA 12V-7.2Ah
Recommended replacement Battery (Part No.)	-	-	075188	075188	000459	000459	000442 or 033931	(2x) 033931	(2x) 033931
Recommended number of earth stakes	1x0,5m	1x0,5m	1x0,5m	1x1m	1x1m	1x1m	2x1m	2x1m	4x1m
Suitable Stand (height)	Ringtop post (max.12mm)	Ringtop post (max.12mm)	730003 (50cm) 007509 (88cm)	730003 (50cm) 007509 (88cm)	730003 (50cm) 007509 (88cm)	730003 (50cm) 007509 (88cm)	730003 (50cm) 007509 (88cm)	730003 (50cm) 007509 (88cm)	730003 (50cm) 007509 (88cm)
Compliance	EN60335-2-76-A11	EN60335-2-76-A11	EN60335-2-76-A11	EN60335-2-76-A11	EN60335-2-76-A11	EN60335-2-76-A11	EN60335-2-76-A11	EN60335-2-76-A11	EN60335-2-76-A11
IPX classification	IPX4	IPX4	IPX4	IPX4	IPX4	IPX4	IPX4	IPX4	IPX4
Warranty	3 years	3 years	3 years	3 years	3 years	3 years	3 years	3 years	3 years
Dimensions (lxbxh mm)	140x50x165	140x50x165	175x180x250	175x180x250	205x305x275	205x305x275	215x355x310	330x305x472	660x305x472
Weight (Kg)	0,93	0,93	1,9	2,1	4	4	5	12,2	14,4

▪ Standard / suitable for ○ Optional - Not compatible / not suitable for



Our energizers are marked in accordance with the European Directive 2012/19/EU regarding Waste Electrical and Electronical Equipment (WEEE Directive). In case you want to dispose of energizer, you may not treat this device should not be treated as municipal waste. The device should be delivered to the selling point where you have bought this or returned without charge to Gallagher Europe. By doing so you contribute to the processing of the device in an appropriate manner and to the prevention of possible harmful consequences for the environment and public health.

Specifications of the Solar Kits

S220 S230



	061556	060870
Energizer	B200	
Battery	Premium Turbo AGM 60Ah	Premium Turbo AGM 75Ah
Solar panel (W)	20W	30W
Solarbracket	▪	▪
Output Voltage (V)	9000	
Output with 500 Ohm (V)	4300	
Stored Energy (J)	1,5	
Output Energy (J)	1,1	
Single Wire Fence distance - Ideal conditions (km)	60	
Multi (2) Wire Fence distance - Ideal conditions (km)	20	
Multi (2) Wire Fence distance - Light conditions (km)	7	
Multi (3) Wire Fence distance - Recommended (km)	5	
Grid area (Hec/Acre)	10/25	
Avg. current draw 12V Battery (mA)	120	
Avg. current draw safemode 12V Battery (V/mA)	40	
Horse, Cattle	▪	
Sheep, Goat	▪	
Pig	▪	
Game	▪	
Battery safemode	▪	
Battery LED (indicator)	▪	
Auto power conservation to prevent damage to battery	▪	
Half power mode	▪	
Day savings option	▪	
Night savings option	▪	
Normal - slow pulse mode	▪	

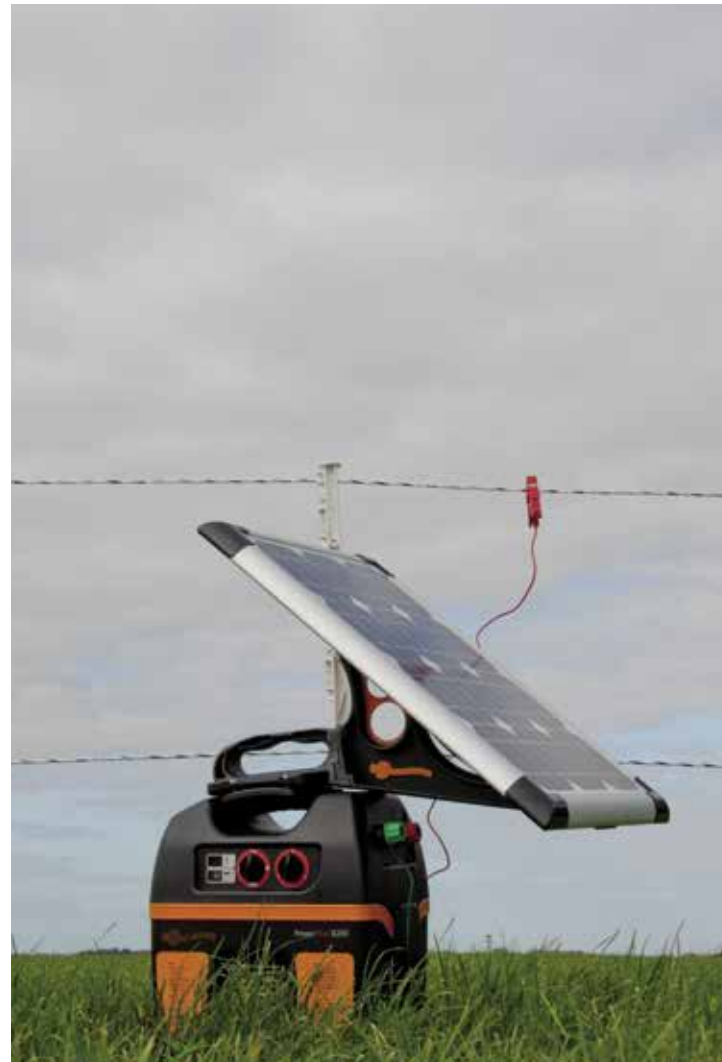

Specifications of the Solarstation

what is included		MBS2800i	MBS1800i	MBS800
Image	Part Description	083053	083060	083077
		Included	Included	Included
1	Energizer MBS2800i - 230V/12V/21J	Y	-	-
1	Energizer MBS1800i - 230V/12V/14J	-	Y	-
1	Energizer MBS800 - 230V/12V/Solar/7,5J	-	-	Y
2	i Series Energizer Controller	Y	Y	-
3	Victron BlueSolar MPPT 100/30 Solar charge controller	Y	Y	Y
4	Solar module 340 Watt	*Y	*Y	*Y
5	Victron Smart Battery Protect BP-65	Y	Y	Y
6	AGM Battery Panasonic 120Ah LC-P12120P	4x	2x	2x
	Bentonite Super Earthing Mix (6,5kg)	3x	2x	1x
	Earth stake 1m	7x	5x	3x
	Earth socket	3x	2x	2x
	Earth clamp	4x	3x	2x
	Lead out Cable 2,5mm	40m	30m	10m
	Joint Clamp angle with hex nut	10x	10x	10x
	Alu shield Solarstation	3x	3x	3x
	Manual SolarPower Station	Y	Y	Y
	Metal Box 1100x1200x1100mm	Y	Y	Y
	Plastic Pallet 1200x1200mm	Y	Y	Y
	Dimensions Solar station (LxWxH)	1200x1200x1500	1200x1200x1500	1200x1200x1500
	Total weight approx. Solar station (kg)	245	168	156

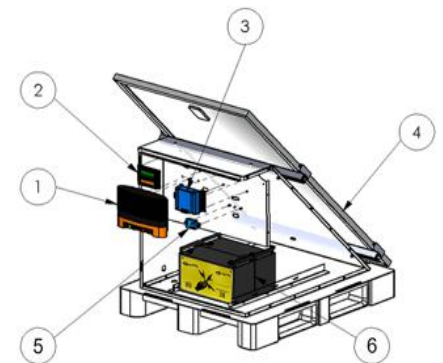



Specifications Solar Panels

	10Watt Solar Panel	20Watt Solar Panel	30Watt Solar Panel	50Watt Solar Panel	60Watt Solar Panel
	041701	041732	041725	027897	041718
Nominal peak power (Wp)	10Watt	20Watt	30Watt	50Watt	60Watt
Nominal voltage (Vmp)	17.3	17.5	17.5	17.5	17.5
Nominal current (Imp)	0.59A	1.15A	1.72A	2.86A	3.43A
Open-circuit voltage (Voc)	21.6	22.0	22.0	22.0	22.0
Short-circuit current (Isc)	0.65A	1.27A	1.90A	3.17A	3.80A
Operating temperature	-40C to +85C	-40C to +85C	-40C to +85C	-40C to +85C	-40C to +85C
Maximum system voltage (DC)	1000V	1000V	1000V	1000V	1000V
Cell Type	Poly-crystalline	Poly-crystalline	Poly-crystalline	Poly-crystalline	Poly-crystalline
Cell Number	36 (4x9)	36 (4x9)	36 (2x18)	36 (4x9)	36 (4x9)
Glass Type	tempered	tempered	tempered	tempered	tempered
Glass Thickness (mm)	3,2	3,2	3,2	3,2	3,2
Build-on controller	2Amp	2Amp	10Amp	10Amp	10Amp
Frame	Anodized Aluminium Alloy	Anodized Aluminium Alloy	Anodized Aluminium Alloy	Anodized Aluminium Alloy	Anodized Aluminium Alloy
Suitable for (minimal advised)*	B20, B60, B100 BA20, BA30	B35, B40, B50, B80 BA40, MB150, MBS200	BA80, B180, MBS200 B200, B300, MB300	B280, MBS400	B700, MBS800 MBS/M i Series
Min. recommended 12V battery (Ah/Ah)	25/65	65/85	85	105	105
Included battery connection lead (m)	2	2	3	3	3
Included crocodile clips	▪	▪	▪	▪	▪
Warranty	2 years	2 years	2 years	2 years	2 years
Length x width x height (mm)	340 x 280 x 17	340 x 450 x 25	340 x 635 x 25	660 x 530 x 35	660 x 630 x 35
Weight (kg)	1,1	1,8	2,5	4,2	5,0

Available accessories (not included)

073511 - Gallagher Solarbox	▪	▪	▪	-	-
077328 - Solarbox bracket (extention bracket for Solarbox)	-	-	-	▪	▪
069774 - Bracket for post, wall and anti-theft box.	▪	▪	▪	-	-
069781 - Bracket for post, wall and anti-theft box.	-	-	-	▪	▪
068709 - Solarpanel bracket for B100, B200 and B300	▪	▪	▪	-	-

MultiPower Energizers

12V Battery Energizers

	Part No.	Ah	Dimensions LxWxH mm	Weight (Kg)	MultiPower Energizers					12V Battery Energizers						
					MB150 388311	MB300 388328	MB1000 301303	MBS200 389318	MBS400 390307	MBS800 390314	B20 028818	B35 356433	B40 386317	B50 028931	B100 392004	B200 393001
12Volt PremiumTurbo AGM	086382	100Ah	353x238x165	26,5	▪	▪	▪	▪	▪	▪						
	086399	75Ah	278x175x190	20,5	▪	▪	▪	▪	▪	▪				▪	▪	▪
	086405	60Ah	242x175x190	17,8	▪	▪	▪	▪	▪	▪				▪	▪	▪
12Volt Premium LA	086351	105Ah	353x175x190	21,5	▪	▪	▪	▪	▪	▪						
	086368	80Ah	278x175x190	16,5	▪	▪	▪	▪	▪	▪				▪	▪	▪
	086375	65Ah	242x175x190	14	▪	▪	▪	▪	▪	▪				▪	▪	▪
12Volt VRSLA	033553	25Ah	166x175x125	8,0							(vertical)	(vertical)	(vertical)	(vertical)		
	047031	12Ah	151x98x101	3,7												
	033931	7.2Ah	151x65x94	2,5												
	047024	5Ah	90x70x107	1,45												
9Volt Air Alkaline	063451	210Ah	190x125x160	4,6							▪	▪	▪	▪	▪(2x)	
	048588	175Ah	190x125x160	3,125							▪	▪	▪	▪	▪(2x)	
	008711	160Ah	190x125x160	3,075							▪	▪	▪	▪	▪(2x)	
	008704	120Ah	160x110x115	2,6							▪	▪	▪	▪		
6V VRSLA	007578	55Ah	160x110x115	1,6							▪	▪				
	000459	10Ah	151x50x94	1,7												
	075188	4Ah	70x45x105	0,71												

Specifications Tape

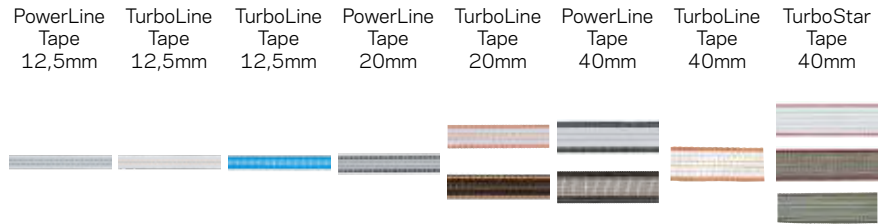

	PowerLine Tape 12,5mm	TurboLine Tape 12,5mm	TurboLine Tape 12,5mm	PowerLine Tape 20mm	TurboLine Tape 20mm	PowerLine Tape 40mm	TurboLine Tape 40mm	TurboStar Tape 40mm
	062303 026237	076232 086231 079445 079438	079391	106236	007608 060702	006246 060696	007592	072439 010608 070862 072446 010615 070879 010516
Colour	White/black	White/ orange	Blue	White/black	White/ orange Terra/ orange	White/black Terra/black"	White/ orange	White/orange Green/orange Terra/orange
Metres on roll	100m 200m	200m 400m	200m	200m	200m	200m	200m	100m 200m 350m
Duopak	-	2x200m 2x400m	-	-	-	-	-	-
Width (mm)	12,5	12,5	12,5	20	20	40	40	40
Ø plastic (nylon) wires	0,3	0,38	0,38	0,38	0,38	0,5	0,5	0,5
Number of stainless steel conductors	4	3	3	5	3	11	11	10
Ø stainless steel conductors	0,15mm	2x0,16mm 1x0,20mm	2x0,16mm 1x0,20mm	0,15mm	2x0,16mm 1x0,20mm	0,20mm	10x0,16mm 1x0,20mm	0,20mm
Number of tin-plated copper wires	1	2	2	1	2	1	4	4
Ø tin-plated copper wires	0,25mm	0,25mm	0,25mm	0,25mm	0,25mm	0,25mm	0,25mm	0,30mm
Reinforced lace wire	-	▪	▪	▪	▪	▪	▪	▪
Resistance (Ohm/meter)	0,18	0,09	0,09	0,18	0,09	0,17	0,05	0,04
Tensile strength (kg)	65	100	100	175	200	450	380	520
TurboStar	-	-	-	-	-	-	-	▪
TurboLine	-	▪	▪	▪	▪	-	▪	-
PowerLine	▪	-	-	▪	-	▪	-	-
Horse	▪	▪	▪	▪	▪	▪	▪	▪
Cattle	▪	▪	▪	▪	-	-	-	-
Recommended grid length (m)	< 500	> 500	> 500	< 500	> 500	< 500	> 500	> 500
Voltage at the beginning of the fence	8000V	8000V	8000V	8000V	8000V	8000V	8000V	8000V
at 100m	6000V	7600V	7600V	6000V	7600V	6000V	8000V	8000V
at 500m	4500V	6400V	6400V	4500V	6400V	4400V	7500V	7500V
at 1000m	2500V	5300V	5300V	2500V	5300V	2300V	7000V	7000V
UV guarantee	5 Years	5 Years	5 Years	5 Years	5 Years	5 Years	5 Years	7 Years



Specifications Vidoflex & Polywire

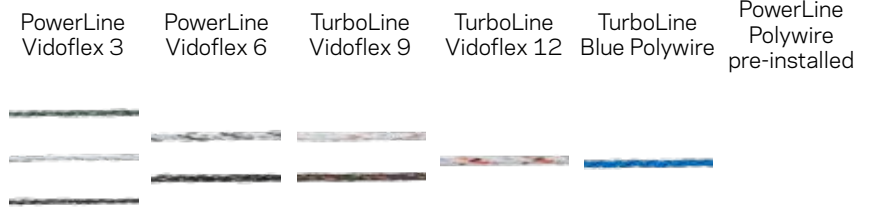

	PowerLine Vidoflex 3	PowerLine Vidoflex 6	TurboLine Vidoflex 9	TurboLine Vidoflex 12	TurboLine Blue Polywire	PowerLine Polywire pre-installed
	019335 010554 063987	021680 021697 054855 063970 072422	011247 011254 049028 054862 075775 069316 069323 079421	079377	079384 075829 072477 079452	061184 (Twined - similar to Vidoflex 3)
Colour	White, Green, Terra	White, Terra	White/orange Terra/orange	White/orange/ black	Blue	White/black
Metres on roll	100m 200m	200m 400m 1000m	200m 400m 1000m	400m	200m 400m 1000m	500m
Duopak	-	-	2x200m 2x400m 2x1000m	-	2x400m	-
Diameter (mm)	2	2,5	3	3	3	2
Number of plastic (nylon) threads	18	18	24	35	21	18
Ø plastic (nylon) wires	0,25mm	0,30mm	0,25mm	0,25mm 0,35mm	0,38mm	0,25mm
Number of stainless steel wires	6	6	6	6	-	-
Ø stainless steel wires	0,15mm	0,20mm	0,15mm	0,20mm	-	-
Number of stranded copper wires	-	-	3	4	3	-
Ø tinned copper wires	-	-	0,25mm	0,25mm	0,25mm	-
Resistance (Ohm/meter)	6,8	3,8	0,06	0,046	0,06	6,0
Tensile strength (kg)	47	80	105	105	105	60
TurboLine	-	-	▪	▪	▪	-
PowerLine	▪	▪	-	-	-	▪
Sheep, goats	▪	▪	▪	▪	-	▪
Cattle	▪	▪	▪	▪	-	▪
Big game	▪	▪	▪	▪	▪	▪
Small game	-	-	-	-	▪	-
Recommended grid length (m)	< 500	< 500	> 500	> 500	> 500	< 500
Voltage at the beginning of the fence	8000V	8000V	8000V	8000V	8000V	8000V
at 100 m	3600V	4900V	7800V	7900V	7800V	3600V
at 500 m	1100V	2300V	7000V	7400V	7000V	1100V
at 1000 m	600V	1400V	6400V	6900V	6400V	600V
UV guarantee	5 Years	5 Years	5 Years	5 Years	3 Years	2 Years



Specifications Cord

EconomyLine Cord

PowerLine Cord

TurboLine Cord



	063918 063932	063925 063949	063963 072460	063956 072453	057856 056101 069293 069798	058006 057993 069309 069804
Colour	White/black Terra/black		White/black Terra/black		White/orange Terra/orange	
Meters on spool	100m 200m 500m		200m 500m		200m 500m	
Duopack	-		-		2x200m 2x500m	
Diameter (mm)	5		5+		6+	
Ø plastic (nylon) wires	0,2		0,3		0,3	
Number of stainless steel wires	5		5		8	
Ø stainless steel wires	0,2mm		0,2mm		0,2mm	
Number of tinned copper wires	-		1		3	
Ø tinned copper wires	-		0,25		2x0,25mm 1x0,30mm	
Resistance (Ohm/meter)	3,82		0,18		0,06	
Tensile strength (kg)	330		330		430	
TurboLine	-		-		▪	
PowerLine	-		▪		-	
EconomyLine	▪		-		-	
Horse	▪		▪		▪	
Cattle	▪		▪		▪	
Wild	-		-		▪	
Recommended fence length (m)	< 500		< 500		> 500	
Voltage at the beginning of the fence	8000V		8000V		8000V	
at 100m	4700V		6000V		8000V	
at 500m	2000V		4500V		7500V	
at 1000m	1000V		2500V		7000V	
UV warranty	3 Years		5 Years		7 Years	



GALLAGHER

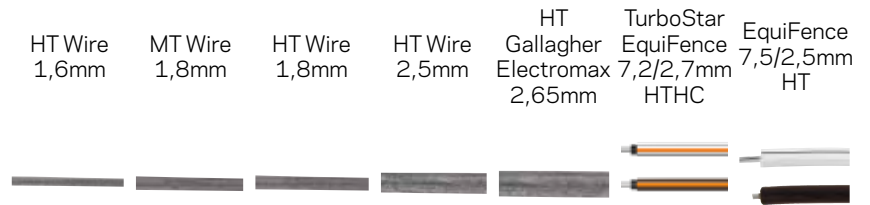

	004195 004188	060412	077311	039999	069385	912042 912240	009124 053858
Colour	Metal	Metal	Metal	Metal	Metal	White, Terra, Orange 4 conducting lines	White, Terra 3 conducting lines
Meters spool	315m 1580m	500m	1250m	625m	600m	250m	250m
Diameter (mm)	1,6	1,8	1,8	2,5	2,65	7,8	7,5
Number of conductors	1	1	1	1	1	1	1
Ø Conductors in mm	1,6	1,8	1,8	2,5	2,65	2,7	2,5
Resistance (Ohm/meter)	0,07	0,067	0,050	0,035	0,029	0,0115	0,035
Tensile strength (kg)	220	250	350	500	550	400	500
High Tensile	▪	-	▪	▪	▪	▪	▪
Medium Tensile	-	▪	-	-	-	-	-
Special features	zinc aluminum magnesium coating	zinc aluminum magnesium coating	zinc aluminum magnesium coating	zinc aluminum magnesium coating	zinc aluminum magnesium coating	2,7mm galvanized High tensile High conductive core shielded by white or terra non conductive plastic with 4 layers of black conductive carbon.	2,5mm galvanized core shielded by white or terra non conductive plastic with 3 layers of black conductive carbon.
Horse	-	-	-	-	-	▪	▪
Cattle	▪	▪	▪	▪	▪	-	-
Pig	-	▪	▪	▪	-	-	-
Sheep	▪	▪	▪	▪	▪	-	-
Goat	▪	▪	▪	▪	▪	-	-
Game	▪	▪	▪	▪	▪	-	-
Recommended fence length (m)	> 500	> 500	> 500	> 500	> 500	< 500	< 500
Voltage at the beginning of the fence	8000V	8000V	8000V	8000V	8000V	8000V	8000V
at 100m	8000V	8000V	8000V	8000V	8000V	8000V	8000V
at 500m	7500V	7600V	7700V	7800V	7950V	7900V	7700V
at 1000m	7000V	7100V	7300V	7500V	7800V	7800V	7500V
Warranty	10 years	10 years	10 years	10 years	10 years	10 years	10 years





Gallagher

Table of Gallagher products and prices, including items like M5000i, MBS1800i, Solar Powerstation, Earth Stake, Earth Clamp, Earth Socket, Earth Stake 0,5m + 3m cable, Earthstake 1,7m with earth clamp, Earthstake 1m with earth clamp, Earthstake 1m without earth clamp, Earthstake 2m with earth clamp, Lead-out connector, Regulator 10A for >30W Solar panels, Regulator 2A for 10/20W Solar panel, Solar bracket 10/20/30W Solar panel, Solar bracket 50/60W Solar panel, Solar bracket B100/B200/B300, Solar panel 10W incl. 2A regulator, Solar panel 20W incl. 2A regulator, Solar panel 30W incl. 10A regulator, Solar panel 50W incl. 10A regulator, Solar panel 60W incl. 10A regulator, i Series Fence Monitor, i Series WiFi Gateway, 12V Battery Backup system, Aluminium EU Warning sign, Cut out switch, EU Warning sign (universal), Flashlight, Flood Gate Controller (5600 Ohm), i Series Alarm System, Lightning diverter, Siren, SMS remote control with Power failure alarm (GSM), Fence and Earth connection lead for 9V/12V Energizers, 12V Battery connection lead for 9V Energizers, 12V Battery connection lead for 9V/12V Energizers, 12V Battery connection lead for B60 (1), 12V Battery Lead set MB/MBS Series, Crocodile clip green, Crocodile clip red, PowerSupply 230V/15V MB/MBS, PowerSupply 230V/15V MBSi, Battery Fault Finder, Electric fence Keyring Beeper, Fault Finder, Fence Voltmeter, i Series Remote Controller, Live Fence Indicator, Neontester, Pet and Garden kit 80cm M35 230V, Pet and Garden kit 80cm S6 Solar, Cat kit for fence M35 230V, Pond and Garden kit 50cm M35 230V, Pond and Garden kit 50cm S6 Solar, Starter kit M35 230V, FoxlightS, Gutter clamp insulator Marten Kit, Marten kit M50 230V, Pouly kit B60 12V, Rainpipe clamp Insulator Marten Kit, Snailfence Junctionbox, SnailFence kit S6 Solar (20m), SnailFence tape extension kit 20m, SnailFence tape extension kit 50m, Insultimber (FSC®) Dropper 110x3,8x2,6cm, Insultimber (FSC®) Dropper 126x3,8x2,6cm, Insultimber (FSC®) Dropper 156x3,8x2,6cm, Insultimber (FSC®) Dropper 95x3,8x2,6cm, Insultimber (FSC®) Post 150x3,8x3,8cm, Insultimber (FSC®) Post 180x3,8x3,8cm, Insultimber (FSC®) Post 210x5x5cm, Insultimber (FSC®) Strainer post 200x8x8cm, Insultimber (FSC®) Strainer post 250x10x10cm, Insultimber (FSC®) Strut 200x4x8cm, Gallagher Insulated Line Post 1,40m, Gallagher Insulated Line Post 1,90m, Gallagher Insulated Line Post 2,05m, Gallagher Insulated Line Post Dropper 0,95m 5 wire, Screw-in Tie Down, Tie Down Handle for Screw-in Tie Down, Eco post 150x7cm, Eco post 185x7cm, Duopack Horse post terra 1,55m (2x5), Duopack Horse post white 1,55m (2x5), Horse post terra 1,05m, Horse post terra 1,55m, Horse post white 1,55m, Duopack Vario post terra 1,00m (2x10), Duopack Vario post white 1,00m (2x10), Hobby post terra 0,75m, Hobby post white 0,75m, Plastic Wolf post 1,55m, white, Vario post terra 1,00m, Vario post white 1,00m, Multi wire post Insulator Orange, Multi wire post Insulator White, Multi wire post white 1,50m, Multi wire Quattro post 1,00m, Multi wire Ring Top post white 1,10m, Ring Top post 1,00m, Spring steel post 1,00m, Click-on insulator for Spring steel post, Orange Pigtail post 1,00m, Spring steel Pigtail post 1,10m, Topinsulator for Spring steel post, Fibreglass post white 10mm 1,25m, Fibreglass post white 10mm 1,50m, Garden/Pond post black 0,50m, Plastic post black 13mm 0,70m, Plastic post black 13mm 0,98m, Plastic post black 19mm 1,70m, Plastic post black 19mm 2,00m, Plastic post blue 13mm 0,70m, Plastic post blue 13mm 1,00m, Plastic post blue 13mm 1,50m, Stainless steel Clip for Fibreglass post 10mm, Stainless steel Clip for Plastic post 13mm, Stainless steel Clips for Plastic post 19mm, Topinsulator Plastic post 13mm, Tumble Wheel, Hub reel with poly wire 102m (1,6mm), Hub reel with turbo wire 102m (1,6mm), SmartFence 2.0, SmartFence 2.0, Multi reel connector set, Reel/Termination post fits 3 Reels/3 Insulators 1,25m, Reel/Termination post fits 5 Reels/5 Insulators 2,00m, Reel/Termination post Reel bracket, Reel/Termination post Support bracket, Triple geared reel stand with wire pre-installed, Econo reel 500m, Geared reel 500m, Geared reel large 1200m, Geared reel pre-installed Polywire 500m, Medium reel 500m, Reel 200m, Reel 400m, Spare drum for Reel 400m, ElectroMax wire 2,65mm - 26kg - 600m, HT zinc-alu-mag wire 1,6mm - 25kg - 1580m, HT zinc-alu-mag wire 1,6mm - 5kg - 315m, HT zinc-alu-mag wire 1,8mm - 25kg - 1250m, HT zinc-alu-mag wire 2,5mm - 25kg - 625m, Equifence terra 7,5mm - 20kg - 250m, Equifence white 7,5mm - 20kg - 250m, Fence Wire Joiner, MT zinc-alu-mag wire 1,8mm - 10kg - 500m, Stranded wire 2,0mm - 3kg - 200m, Stranded wire 2,0mm - 6kg - 400m, TurboStar Equifence terra 250m, TurboStar Equifence white 250m, EuroNetz Sheep netting, Orange 90/2-14/G-50m, EuroNetz Sheep netting, Orange 90/1-14/G-50m, EuroNetz Sheep netting, Orange 90/1-14/W-50m, EuroNetz Sheep netting, Orange 90/2-14/W-50m, EuroNetz Sheep netting, Orange 90/2W14/G-50m, Sheep Netting, Orange 90/1-14/Y-50m, Sheep Netting, Orange 90/2-14/Y-50m, EuroNetz Goat netting, Orange 105/1-14/G-50m, EuroNetz Goat netting, Orange 105/2-14/G-50m, EuroNetz Poultry netting, Green 112/1-15/B-50m, EuroNetz Poultry netting, Green 112/1-9/B-25m, EuroNetz Poultry netting, Green 112/2-15/B-50m, EuroNetz Poultry netting, Orange 112/1-15/G-50m, EuroNetz Poultry netting, Orange 112/2-15/G-50m, EuroNetz Rabbit-/hobby netting, Green 65/1-15/B-50m

077281	EuroNetz Rabbit-/hobby netting, Green 65/1-9/B-25m	60	082285	Wire clip insulator for Gallagher Line Post	67	891064	Elastic rope white 50m	78
022182	EuroNetz Rabbit-/hobby netting, Orange 65/1-15/G-50m	60	060788	XDI screw-in insulator	67	718040	Multi strand gate kit 4x12,5mm tape white 6m	78
086245	Hobby netting, Green 65/1-5/B-15m	60	011193	Screw-in insulator small	68	718842	Multi strand gate kit 4x40mm tape terra 6m	78
062973	EuroNetz Wild boar netting, White 75/1-14/W-50m	61	011209	Screw-in insulator super	68	083084	Retractable auto reel cord terra 18m	78
078677	EuroNetz Wolf netting, Orange 120/2W14/G-50m	61	028498	W-insulator small black	68	054954	Retractable auto reel terra 15m	78
078684	EuroNetz Wolf netting, Orange 120/2W14/G-pos/neg-50m	61	079094	XDI bolt-on insulator	68	010844	Retractable auto reel white 15m	78
083039	Wolf netting, Blue 120/1W14/B-50m	61	071074	Promopack 100x Screw-in Insulator in bag	68	007585	Compression gate handle N-hook black (Stainless steel)	79
079360	Entry gate for EuroNetz electric netting (120x100cm)	62	060894	Screw-in insulator Economy	68	697000	Soft touch gate handle orange for rope/wire (Stainless steel)	79
072415	EuroNetz Combo netting, Orange 105/1W14/G-50m	62	040728	Screw-in insulator super	69	057979	Soft touch gate handle terra for rope/wire (Stainless steel)	79
075539	EuroNetz Combo netting, Orange 105/2W14/G-50m	62	100003	Corner insulator Extra High Voltage white	69	077441	Batt-Latch Gate Release Timer	79
010356	EuroNetz Combo netting, Orange 90/1-14/G-50m	62	012015	Strain insulator black	69	010783	Gate handle black	79
075584	EuroNetz Combo netting, Orange 90/2-14/G-50m	62	678061	Strain insulator reinforced black	69	010776	Gate handle orange	79
22104	EuroNetz Repair Set Euro and Combo netting	62	011032	Strain insulator reinforced white	69	009084	Spring gate set 5m	79
010493	EuroNetz Turbo netting, White 90/1-14/W-50m	62	021055	W-insulator super black	69	016405	Spring gate set white 5m	79
025473	EuroNetz Turbo netting, White 90/2-14/W-50m	62	079483	High Strain insulator Kit white with stainless steel rope	69	028986	Gate handle anchor 2-way screw-in black	80
069316	Duopack Vidoflex 9 TurboLine Plus White 2x200m	63	067612	W-insulator super white	69	696003	Soft touch gate handle orange for tape (Stainless steel)	80
086436	Duopack Vidoflex 9 TurboLine Plus Terra 2x1000m	63	067617	W-insulator super white	69	057986	Soft touch gate handle terra for tape (Stainless steel)	80
086443	Duopack Vidoflex 9 TurboLine Plus Terra 2x400m	63	024704	Clips long for Insulntimber/Ecopost	70	738321	Dual Purpose Portable handle	80
079421	Duopack Vidoflex 9 TurboLine Plus White 2x1000m	63	053506	Porcelain corner insulator	70	010769	Gate break joiner 40mm tape	80
069323	Duopack Vidoflex 9 TurboLine Plus White 2x400m	63	086313	Roller screw-in insulator	70	060658	Gate handle anchor 2-way bolt-on black	80
079377	Vidoflex 12 TurboLine Plus White 400m	63	086528	Roller bolt-on insulator (5)	70	021451	Gate handle anchor 3-way screw-on black	80
086290	Vidoflex 9 TurboLine Plus Blue 1000m	63	028955	Rope tensioner	70	086429	Drill chuck Metal	81
075775	Vidoflex 9 TurboLine Plus Terra 1000m	63	024698	Clips short for Insulntimber/Ecopost	71	077397	Drill chuck Pro	81
054862	Vidoflex 9 TurboLine Plus Terra 400m	63	040674	PowerLine Tape insulator	71	004140	Farmer pliers	81
049028	Vidoflex 9 TurboLine Plus White 1000m	63	043880	TurboLine corner/strain insulator with wingnut	71	005225	Gallagher pliers	81
011247	Vidoflex 9 TurboLine Plus White 200m	63	021482	TurboLine Tape insulator	71	050000	Gallagher Screws 4,5x40 T25	81
011254	Vidoflex 9 TurboLine Plus White 400m	63	701042	TurboStar Horse corner/strain Insulator	71	011018	Wire dispenser for fencing wire	81
079452	Duopack TurboLine Blue Polywire 2x400m	64	699066	TurboStar Horse insulator	71	005232	Wire twister	81
069309	Duopack TurboLine rope braided Terra 2x200m	64	082278	TurboStar Tape clip insulator for Gallagher Line Post	71	527017	Line Post Lifter Adapter	82
069804	Duopack TurboLine rope braided Terra 2x500m	64	708027	Connection plate TurboStar Horse corner/strain Insulator	71	540016	Line Post Pilot	82
069293	Duopack TurboLine rope braided White 2x200m	64	082711	Offset screw-in insulator 10cm	72	525013	Line Post Rammer	82
069798	Duopack TurboLine rope braided White 2x500m	64	077274	XDI offset screw-in insulator 10cm	72	530031	Line Post Rammer sleeve	82
072477	TurboLine Blue Polywire 1000m	64	028993	XDI offset screw-in insulator 18cm	72	704668	Post holer 100mm	82
079384	TurboLine Blue Polywire 200m	64	057818	XDI offset screw-in insulator bended 18cm	72	704644	Post holer 75mm	82
075829	TurboLine Blue Polywire 400m	64	077335	Fence Insulator for pos/neg system	72	017652	Rammer Eco post	82
056101	TurboLine rope braided Terra 200m	64	029006	XDI offset bolt-on insulator 20cm/M6	72	035311	Rammer Insulntimber post	82
057993	TurboLine rope braided Terra 500m	64	752334	Live Tip Offset bolt-on insulator 26cm/M6	73	017614	Sledge hammer	82
057856	TurboLine rope braided White 200m	64	006183	Live Tip offset insulator 16cm	73	527000	Universal post Lifter	82
058006	TurboLine rope braided White 500m	64	006190	Live Tip offset insulator 26cm	73	029044	Wire tensioner Basic	82
019335	Vidoflex 3 PowerLine Green 100m	64	006145	Live Tip offset insulator steel post 16cm	73	006451	Wire tensioner Pro	82
063987	Vidoflex 3 PowerLine Terra 100m	64	008780	Mounting bracket Premium 40/60mm M6/M8	73	W&EID		
010554	Vidoflex 3 PowerLine White 200m	64	007516	Offset bolt-on insulator 20cm/M6	73	063300	Heavy Duty Wireless Loadbar set 5000kg - 1000mm	88
063970	Vidoflex 6 PowerLine Terra 200m	64	086481	XDI offset bolt-on insulator 10cm/M6	73	026015	TW-1 Weigh Scale	88
054855	Vidoflex 6 PowerLine Terra 400m	64	010912	Offset Chainlink Insulator 30cm black	74	025001	Weigh scale W0	88
072422	Vidoflex 6 PowerLine White 1000m	64	720234	Offset Pigtail insulator 17,5cm terra	74	061306	Wireless Loadbar set 2500kg - 1000mm	88
021680	Vidoflex 6 PowerLine White 200m	64	010981	Offset Pigtail insulator 17,5cm white	74	060309	Wireless Loadbar set 2500kg - 600mm	88
021697	Vidoflex 6 PowerLine White 400m	64	720135	Offset Pigtail insulator 40cm terra	74	068944	SmartReader HR4	89
063949	EconomyLine rope Terra 200m	65	010998	Offset Pigtail insulator 40cm white	74	033037	SmartReader HR5	89
063918	EconomyLine rope White 100m	65	659046	Offset Pinlock Insulator 30cm black	74	Birth Alarm		
063925	EconomyLine rope White 200m	65	010950	Screw-on rod insulator black for post 4/10mm (20)	74	086467	Birth Alarm Premium Plus	90
063963	PowerLine rope braided Terra 200m	65	656083	Screw-on rod insulator black for post 4/10mm (250)	74	510	Birth Alarm Classic	91
072460	PowerLine rope braided Terra 500m	65	010936	Screw-on rod Insulator green for post 8,5/13mm (20)	74	511	Birth Alarm Classic, incl. anti roll girth	91
063956	PowerLine rope braided White 200m	65	011230	Screw-on rod Insulator green for post 8,5/13mm (250)	74	084555	Birth Alarm Lite 2.0	91
072453	PowerLine rope braided White 500m	65	010943	Screw-on rod Insulator white for post 6/14mm (10)	74	025480	Birth Alarm Mobile	91
007592	TurboLine tape 40mm White 200m	65	751924	Top mount double end Ring Top offset 80cm terra	74	027934	Birth Alarm Mobile Complete, incl. anti-roll girth	91
010516	TurboStar tape 40mm Green 200m	65	603964	Joint clamp angle with wingnut	74	084654	Birth Alarm Mobile Complete, incl. WiFi Camera	91
072446	TurboStar tape 40mm Terra 100m	65	603568	Joint clamp bobbin with hex nut	75	084548	Birth Alarm Premium	91
010615	TurboStar tape 40mm Terra 200m	65	021475	Wire tensioner	75	000655	PoE camera	91
070879	TurboStar tape 40mm Terra 350m	65	056095	Clip lock strainer	75	015018	PoE injector	91
072439	TurboStar tape 40mm White 100m	65	743134	Insulated End Strainer	75	Goodnature		
010608	TurboStar tape 40mm White 200m	65	618005	Insulated End Strainer fastening cable	75	750850	A24 1 Year Replenishment Pack	93
070862	TurboStar tape 40mm White 350m	65	060498	Joint clamp angle with hex nut	75	758641	A24 Automatic rat- and mousetrap with trap counter	93
079445	Duopack TurboLine tape 12,5mm White 2x200m	66	004133	Tension spring for 1,6mm/1,8mm wire	75	483018	A24 Blocker	93
079438	Duopack TurboLine tape 12,5mm White 2x400m	66	036257	Tension spring for 2,5mm/2,65mm HT/EQ wire	75	081936	A24 Lure Basket	93
062303	PowerLine tape 12,5mm White 100m	66	071159	Rope connector	76	725643	A24 Stand - Retail	93
026237	PowerLine tape 12,5mm White 200m	66	028962	Tape joiner 20/40mm	76	750836	A24 tree Mount Kit	93
106236	PowerLine tape 20mm White 200m	66	695303	Handle for tensioner	76	745696	Digital Strike Counter Goodnature A24	93
060696	PowerLine tape 40mm Terra 200m	66	075928	Rope connector with wingnut	76	483117	Goodnature rat lure pouch nut butter 200g (10-pack)	93
006246	PowerLine tape 40mm White 200m	66	055340	Tape connector tape/energizer 130cm	76	758702	Rat Auto Lure Pump	93
079391	TurboLine tape 12,5mm Blue 200m	66	055333	Tape connector tape/tape 60cm	76	483025	Rodent Detector Kit- 25 Pack	93
076232	TurboLine tape 12,5mm White 200m	66	028979	Tape joiner 12,5/20mm	76			
086231	TurboLine tape 12,5mm White 400m	66	060764	Vidoflex connector	76			
086306	TurboLine tape 20mm Blue 200m	66	004164	Drive thru Electro gate 3,7m	77			
060702	TurboLine tape 20mm Terra 200m	66	054923	Drive thru Electro gate 5,0m	77			
007608	TurboLine tape 20mm White 200m	66	001064	Electrified steel gate 2,5 up to 4,5m	77			
			075935	Mobile Cattle grid 2,4 x 1,3m (LxW)	77			
			086542	Mobile Cattle grid 3,0 x 2,4m (LxW)	77			
			085576	Mobile Cattle grid 3,0 x 4,0m (LxW)	77			
			086535	Mobile Cattle grid 4,0 x 3,0m (LxW)	77			
			072354	Elastic rope gate set terra 3/6m	78			
			016412	Elastic rope gate set white 3/6m	78			
			640556	Elastic rope gate set white 6,5/11m	78			
			891163	Elastic rope terra 50m	78			

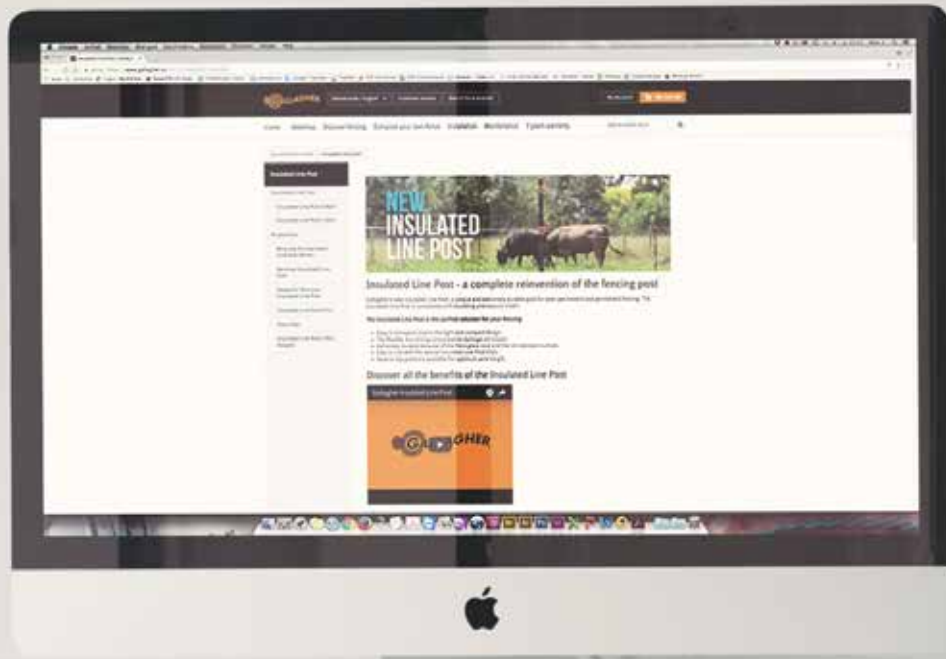

WE KEEP YOU INFORMED ONLINE!

ORDER NOW ONLINE

It is easy to order your products from our website and pick it up at your preferred dealer. You can find our entire range on the website. If you are not sure which components you need for your fencing please consult your dealer or contact Gallagher. We are all pleased to give you customised advice!

www.gallagher.eu

FOLLOW US ON FACEBOOK

We have regular special offers and promotions on Facebook, but also information about our presence at fairs or stories with photos from Gallagher users. Make sure you don't miss anything and follow us on

www.facebook.com/GallagherUK

SUBSCRIBE TO OUR YOUTUBE CHANNEL

Discover how you can check your Gallagher fence or install an energizer. It also has all the information about our latest products. All in easy and short videos. Subscribe quickly and stay up to date!

www.youtube.com/GallagherEuropeBV

Your Gallagher dealer:

Colour and appearances may slightly differ to those of the actual items.

Colour and appearances may slightly differ to those of the actual items.



1133ENG © 2022